

A modern living room interior featuring a white sectional sofa with patterned and solid pillows, a white coffee table with a plant, and a track lighting system on the ceiling. The room has large windows with dark curtains and a minimalist aesthetic.

**TOPE**   
**LIGHTING**  
[WWW.TOPELIGHTING.COM](http://WWW.TOPELIGHTING.COM)

**TOPE LIGHTING CATALOGUE  
2024**



# ABOUT US

"Tope Lighting" is a reliable manufacturer and supplier of LED luminaires, known not only in Lithuania, but also in Europe.

Our mission is to develop luminaires and their technologies in order to obtain the best ratio of parameters, quality and price.

## **We produce lighting solutions for:**

- individual houses,
- offices,
- warehouse or factory premises,
- outdoor,
- smart homes.

Our goal is to offer high-quality, innovative LED luminaires that meet all standards, are easy to install and save not only installation time but also money. Depending on our customer and his needs, we are constantly looking for innovations and the most modern lighting solutions, so we add new products to the range every year.

We are the first in Lithuania who offer customers quickly and conveniently calculate the required lighting using a lighting calculator created by us.

For those who want intelligence and even more convenience, we offer LED luminaires controlled by a remote control – adjusting the light spectrum (Kelvin) and the lighting intensity. Also, we can offer LED luminaires with 0-10V or TRIAC intensity control, artificial lighting system – DALI. In our range, we also have luminaires for projects with emergency lighting power supplies for the offices and warehouses or industrial premises.

Customer needs are our concern.

**TOPE**   
**LIGHTING** 

LED STRIPS



17 | KANO



18 | KARA



19 | KOBE 20 | ACCESSORIES

RECESSED LED LUMINAIRES

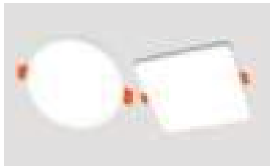

22 | ROSA  
ROUND/SQUARE

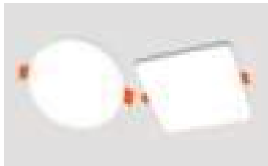

23 | ROSA R/S 0-10V DIMMABLE  
ROSA R/S EMERGENCY

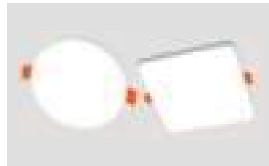

24 | RONDA ROUND/SQUARE  
25 | RONDA R/S 0-10V DIMMABLE



26 | PLASTIC SURFACE  
MOUNTED PLATE

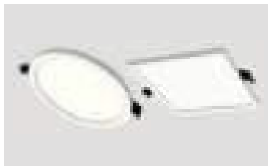

27 | SPLIT  
ROUND/SQUARE



28 | SPLIT ROUND  
BLACK



29 | AIRA  
ROUND/SQUARE



30 | LENS  
ROUND/SQUARE



31 | ANDA

CEILING LED LUMINAIRES



33 | MEKA



34 | MORA



35 | MORA 0-10V DIM / TRIAC\_DIM /  
REMOTE CONTROL / EMERGENCY



36 | SORA



36 | SORA  
SENS

37 | RIGA



38 | RIO  
RIO SENS



39 | MODENA  
ROUND/SQUARE



40 | MODENA ROUND  
BLACK



41 | TORA  
ROUND/SQUARE

LED SMART LIGHTING



43 | BOLTON  
WHITE/BLACK



44 | BOSTON  
WHITE/BLACK



45 | SOPOT ROUND



46 | SOPOT SQUARE

LED PANELS



48 | MESA 27W UGR<19



49 | MESA 27W UGR<19 DIMMABLE  
0-10V



49 | MESA 27W UGR<19  
DALI / EMERGENCY



50 | MESA 27W



51 | MESA 27W DIMMABLE  
0-10V



51 | MESA 27W  
DALI / EMERGENCY



52 | MESA UGR<19



53 | MESA UGR<19 DIMMABLE  
0-10V / TRIAC



53 | MESA UGR<19  
DALI / EMERGENCY



54 | MESA



55 | MESA DIMMABLE  
0-10V / TRIAC



55 | MESA  
DALI / EMERGENCY



56 | BRIG  
BRIG EMERGENCY



57 | BURGAS  
BURGAS 0-10V  
DIMMABLE / EMERGENCY



58 | ACCESSORIES

LED SPOTLIGHTS



60 | OSLO



61 | TELA



62 | TULSA



63 | TANGA



64 | TARTU

MAGNETIC LED SYSTEM



66 | TAMPA

67 | TAMPA MAGNETIC LED SYSTEM



68 | TAMPA\_WH

69 | TAMPA MAGNETIC LED SYSTEM\_WH

LED TRACK SYSTEM 3 WIRE



71 | TALA

72 | TALA LED TRACK SYSTEM 3 WIRE

LED LINEAR LIGHT



74 | LOTA100 UGR<19



75 | LOTA100 UGR<19  
0-10V DIMMABLE / DALI / SENS



76 | LOTA UGR<19  
LOTA UGR<19 SENS



77 | LOTA100



78 | LOTA100  
0-10V DIMMABLE / DALI / SENS



79 | LOTA



80 | LIMAN100



81 | LIMAN100 DIMMABLE  
0-10V / TRIAC  
LIMAN100 WITH  
REMOTE CONTROL



82 | LIMAN100 DALI /  
SENSOR / EMERGENCY



83 | LIMAN100  
HIGH POWER



84 | LIMAN100 HIGH POWER  
0-10V DIMMABLE / SENSOR /  
EMERGENCY



85 | LIMAN  
LIMAN EMERGENCY



86 | ACCESSORIES



87 | ESNA100



88 | ESNA 100 0-10V DIMMABLE /  
TRIAC DIMMABLE  
ESNA100 WITH REMOTE CONTROL





89 | ESNA100 /  
DALI / EMERGENCY



90 | ESNA100 HIGHT POWER



91 | ESNA100 HIGHT POWER  
0-10V DIMMABLE / EMERGENCY



92 | ESNA  
ESNA EMERGENCY

**LED LINEAR OUTDOOR / INDOOR LIGHT**



95 | TAMNA\_W



96 | TAMNA\_B



97 | TAMNA\_G



98 | TAMNA\_SENS\_W



99 | TAMNA\_SENS\_B



100 | TAMNA\_SENS\_G



101 | TAMNA\_TRIAC DIM\_W



102 | TAMNA\_TRIAC DIM\_B



103 | TAMNA\_TRIAC DIM\_G



107 | TAMNA\_WOOD\_W



108 | TAMNA\_WOOD\_BR



109 | TAMNA\_WOOD\_A



110 | TAMNA\_WOOD\_BL



111 | TAMNA\_WOOD\_TRIAC DIM\_W



112 | TAMNA\_WOOD\_TRIAC DIM\_BR



113 | TAMNA\_WOOD\_TRIAC DIM\_A



114 | TAMNA\_WOOD\_TRIAC DIM\_BL

LED INDUSTRIAL LIGHT



116 | URAN 30°/90°  
URAN 30°/90° EMERGENCY



117 | URAN 80°/110°  
URAN 80°/110° EMERGENCY



118 | UNA



119 | UBE  
UBE EMERGENCY



120 | LION  
LION EMERGENCY



121 | NIDA CCT  
NIDA /ACCESSORIES

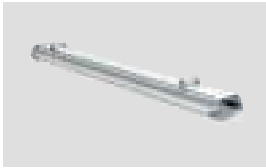

122 | NOSTRA



123 | NITRA



124 | NOLA



125 | NAKA



126 | LAOS  
LAOS EMERGENCY

## LED EXPLOSION PROOF LIGHT



PROJECT CATEGORY

128 | EMET



PROJECT CATEGORY

129 | ENID



PROJECT CATEGORY

130 | ELGIN

## LED OUTDOOR LIGHT



132 | SAGA / SAGASENS

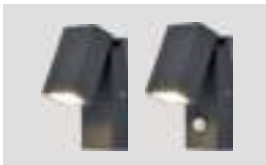

133 | SETO / SETOSENS



134 | SOMA / SOMASENS

## CONTENTS

---



135 | SANO / SANOSENS



136 | SALTA\_WA / SALTASENS\_WA



137 | SALTA\_BO / SALTASENS\_BO



138 | SALTA\_GR / SALTASENS\_GR

## LED FLOODLIGHT



140 | TENRI



141 | VISTA\_B\_W



142 | BRENT  
BRENT SENS



143 | TAMASENS



144 | TOLEDO



145 | TOLEDO SENS\_PRO

## CONTENTS

---

### LED STREET LIGHT



PROJECT CATEGORY

147 | HEMET



PROJECT CATEGORY

148 | HEZE



149 | HABI

### PARK LIGHT



PROJECT CATEGORY

151 | GIZA

### LED HIGH MAST LIGHT



PROJECT CATEGORY

153 | DINA



PROJECT CATEGORY

154 | DEVA



PROJECT CATEGORY

155 | TOGAN



PROJECT CATEGORY

156 | NOTA



PROJECT CATEGORY

157 | TRENTON

**CONTENTS**

---

**VESTA\_NARROW**



158 | VESTA NARROW 4000K

**VESTA**



159 | VESTA ROUND/SQUARE



159 | VESTA SQUARE



160 | VESTA GLASS ROUND/SQUARE

**MODOLED\_NARROW**

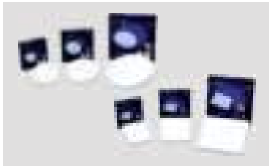

161 | NARROW ROUND/SQUARE

## CONTENTS

---

### ■ MODOLED



162 | MODOLED  
ROUND/SQUARE



163 | MODOLED GLASS  
ROUND/SQUARE



163 | MODOLED  
SQUARE



164 | MODOLED FLOODLIGHT  
WITH PIR SENSOR

### ■ ALBA-BELA | P109-110



165 | ALBA



166 | BELA

A photograph of a wooden staircase with a glowing LED strip light installed along the wall. The light strip follows the contour of the wall, creating a zigzag pattern that highlights the steps. The wall is made of horizontal wooden planks, and the stairs are also made of wood. The lighting is warm and creates a modern, minimalist aesthetic.

# LED STRIPS

**TOPE** of  
**LIGHTING**



SAMSUNG  
SMD2835

130lm/w

2 OZ PCB,  
5m/roll

Ra&gt;90

CE

RoHS  
COMPLIANT

  
WARRANTY

## SPECIFICATIONS

- Flexible LED strips DC24V. 2 OZ PCB. 3M tape.
- IP20, IP67. SAMSUNG SMD2835 LED chips.
- 5000mm rolls. Complete with 3000K and 4000K LED's
- Rated median usefull life: L80B10<50000H

## MODELS

| CODE      | MODEL                          | POWER | VOLTAGE | DIMENSION | LUMEN  | IP                     | KELVIN |
|-----------|--------------------------------|-------|---------|-----------|--------|------------------------|--------|
| 600100001 | KANO130_4.8W_64LED_3K_624      | 4.8W  | 24V     | 5000x8mm  | 624lm  | IP20<br>NON-WATERPROOF | 3000K  |
| 600100002 | KANO130_4.8W_64LED_4K_624      | 4.8W  | 24V     | 5000x8mm  | 624lm  | IP20<br>NON-WATERPROOF | 4000K  |
| 600100003 | KANO130_4.8W_64LED_IP_3K_624   | 4.8W  | 24V     | 5000x8mm  | 624lm  | IP67<br>WATERPROOF     | 3000K  |
| 600100004 | KANO130_4.8W_64LED_IP_4K_624   | 4.8W  | 24V     | 5000x8mm  | 624lm  | IP67<br>WATERPROOF     | 4000K  |
| 600100005 | KANO130_9.6W_120LED_3K_1248    | 9.6W  | 24V     | 5000x10mm | 1248lm | IP20<br>NON-WATERPROOF | 3000K  |
| 600100006 | KANO130_9.6W_120LED_4K_1248    | 9.6W  | 24V     | 5000x10mm | 1248lm | IP20<br>NON-WATERPROOF | 4000K  |
| 600100007 | KANO130_9.6W_120LED_IP_3K_1248 | 9.6W  | 24V     | 5000x10mm | 1248lm | IP67<br>WATERPROOF     | 3000K  |
| 600100008 | KANO130_9.6W_120LED_IP_4K_1248 | 9.6W  | 24V     | 5000x10mm | 1248lm | IP67<br>WATERPROOF     | 4000K  |
| 600100009 | KANO130_14.4W_160LED_3K_1872   | 14.4W | 24V     | 5000x10mm | 1872lm | IP20<br>NON-WATERPROOF | 3000K  |
| 600100010 | KANO130_14.4W_160LED_4K_1872   | 14.4W | 24V     | 5000x10mm | 1872lm | IP20<br>NON-WATERPROOF | 4000K  |
| 600100011 | KANO130_18W_192LED_3K_2340     | 18W   | 24V     | 5000x10mm | 2340lm | IP20<br>NON-WATERPROOF | 3000K  |
| 600100012 | KANO130_18W_192LED_4K_2340     | 18W   | 24V     | 5000x10mm | 2340lm | IP20<br>NON-WATERPROOF | 4000K  |
| 600100013 | KANO130_21.6W_240LED_3K_2808   | 21.6W | 24V     | 5000x10mm | 2808lm | IP20<br>NON-WATERPROOF | 3000K  |
| 600100014 | KANO130_21.6W_240LED_4K_2808   | 21.6W | 24V     | 5000x10mm | 2808lm | IP20<br>NON-WATERPROOF | 4000K  |

EPISTAR  
SMD2835

100lm/W

2 OZ PCB,  
5m/roll

Ra&gt;90

RoHS  
COMPLIANT

  
WARRANTY

## SPECIFICATIONS

- Flexible LED strips DC12/24V. 2 OZ PCB. 3M tape.
- IP20, IP67. Epistar SMD2835 LED chips.
- 5000mm rolls. Complete with 3000K and 4000K LED's
- Rated median usefull life: L80B10<50000H

## MODELS

| CODE      | MODEL                         | POWER | VOLTAGE | DIMENSION | LUMEN  | IP                     | KELVIN |
|-----------|-------------------------------|-------|---------|-----------|--------|------------------------|--------|
| 600100015 | KARA100_4.8W_60LED_3K_485     | 4.8W  | 12V     | 5000x8mm  | 485lm  | IP20<br>NON-WATERPROOF | 3000K  |
| 600100016 | KARA100_4.8W_60LED_4K_485     | 4.8W  | 12V     | 5000x8mm  | 485lm  | IP20<br>NON-WATERPROOF | 4000K  |
| 600100017 | KARA100_4.8W_60LED_IP_3K_485  | 4.8W  | 12V     | 5000x8mm  | 485lm  | IP67<br>WATERPROOF     | 3000K  |
| 600100018 | KARA100_4.8W_60LED_IP_4K_485  | 4.8W  | 12V     | 5000x8mm  | 485lm  | IP67<br>WATERPROOF     | 4000K  |
| 600100019 | KARA100_9.6W_120LED_3K_960    | 9.6W  | 12V     | 5000x8mm  | 960lm  | IP20<br>NON-WATERPROOF | 3000K  |
| 600100020 | KARA100_9.6W_120LED_4K_960    | 9.6W  | 12V     | 5000x8mm  | 960lm  | IP20<br>NON-WATERPROOF | 4000K  |
| 600100021 | KARA100_9.6W_120LED_IP_3K_960 | 9.6W  | 12V     | 5000x8mm  | 960lm  | IP67<br>WATERPROOF     | 3000K  |
| 600100022 | KARA100_9.6W_120LED_IP_4K_960 | 9.6W  | 12V     | 5000x8mm  | 960lm  | IP67<br>WATERPROOF     | 4000K  |
| 600100023 | KARA100_11.2W_140LED_3K_1155  | 11.2W | 24V     | 5000x10mm | 1155lm | IP20<br>NON-WATERPROOF | 3000K  |
| 600100024 | KARA100_11.2W_140LED_4K_1155  | 11.2W | 24V     | 5000x10mm | 1155lm | IP20<br>NON-WATERPROOF | 4000K  |
| 600100025 | KARA100_15W_180LED_3K_1500    | 15W   | 24V     | 5000x10mm | 1500lm | IP20<br>NON-WATERPROOF | 3000K  |
| 600100026 | KARA100_15W_180LED_4K_1500    | 15W   | 24V     | 5000x10mm | 1500lm | IP20<br>NON-WATERPROOF | 4000K  |
| 600100027 | KARA100_15W_180LED_IP_3K_1500 | 15W   | 24V     | 5000x10mm | 1500lm | IP67<br>WATERPROOF     | 3000K  |
| 600100028 | KARA100_15W_180LED_IP_4K_1500 | 15W   | 24V     | 5000x10mm | 1500lm | IP67<br>WATERPROOF     | 4000K  |
| 600100029 | KARA100_18W_210LED_3K_2250    | 18W   | 24V     | 5000x10mm | 2250lm | IP20<br>NON-WATERPROOF | 3000K  |
| 600100030 | KARA100_18W_210LED_4K_2250    | 18W   | 24V     | 5000x10mm | 2250lm | IP20<br>NON-WATERPROOF | 4000K  |



A5000 COB  
LED STRIP

100lm/W

2 OZ PCB,  
5m/roll

Ra>80

CE

RoHS  
COMPLIANT

**5**  
WARRANTY

## SPECIFICATIONS

- Flexible LED strips DC24V. 2 OZ PCB. 3M tape.
- IP20, IP67. Epistar A5000 COB LED strip.
- 5000mm rolls. Complete with 3000K and 4000K LED's
- Rated median usefull life: L80B10<50000H

## MODELS

| CODE      | MODEL                       | POWER | VOLTAGE | DIMENSION | LUMEN  | IP                     | KELVIN |
|-----------|-----------------------------|-------|---------|-----------|--------|------------------------|--------|
| 600100031 | KOBE100_8W_336LED_3K_800    | 8W    | 24V     | 5000x8mm  | 800lm  | IP20<br>NON-WATERPROOF | 3000K  |
| 600100032 | KOBE100_8W_336LED_4K_800    | 8W    | 24V     | 5000x8mm  | 800lm  | IP20<br>NON-WATERPROOF | 4000K  |
| 600100033 | KOBE100_8W_336LED_IP_3K_800 | 8W    | 24V     | 5000x8mm  | 800lm  | IP67<br>WATERPROOF     | 3000K  |
| 600100034 | KOBE100_8W_336LED_IP_4K_800 | 8W    | 24V     | 5000x8mm  | 800lm  | IP67<br>WATERPROOF     | 4000K  |
| 600100035 | KOBE100_10W_528LED_3K_1000  | 10W   | 24V     | 5000x8mm  | 1000lm | IP20<br>NON-WATERPROOF | 3000K  |
| 600100036 | KOBE100_10W_528LED_4K_1000  | 10W   | 24V     | 5000x8mm  | 1000lm | IP20<br>NON-WATERPROOF | 4000K  |
| 600100037 | KOBE100_15W_528LED_3K_1500  | 15W   | 24V     | 5000x10mm | 1500lm | IP20<br>NON-WATERPROOF | 3000K  |
| 600100038 | KOBE100_15W_528LED_4K_1500  | 15W   | 24V     | 5000x10mm | 1500lm | IP20<br>NON-WATERPROOF | 4000K  |

## LED STRIPS ACCESORIES

| PHOTOS | CODE      | MODEL               | NAME   |
|--------|-----------|---------------------|--|
|        | 600110009 | KANO_8MM_60_SS_C    | 8mm width, strip to strip connector  |
|        | 600110010 | KANO_8MM_60_SV_C    | 8mm width, strip to wire connector   |
|        | 600110011 | KANO_8MM_60_SSL_C   | 8mm width, strip to strip wire connector                                   |
|        | 600110012 | KANO_8MM_120_SS_C   | 8mm width, strip to strip connector for 120LED/M and more LED, strip       |
|        | 600110013 | KANO_8MM_120_SV_C   | 8mm width, strip to wire connector for 120LED/M and more LED, strip        |
|        | 600110014 | KANO_8MM_120_SSL_C  | 8mm width, strip to strip wire connector for 120LED/M and more LED, strip  |
|        | 600110015 | KANO_8MM_SS_L_CORN  | 8mm width L corner strip to strip connector                                |
|        | 600110016 | KANO_10MM_60_SS_C   | 10mm width, strip to strip connector                                       |
|        | 600110017 | KANO_10MM_60_SV_C   | 10mm width, strip to wire connector  |
|        | 600110018 | KANO_10MM_60_SSL_C  | 10mm width, strip to strip wire connector                                  |
|        | 600110019 | KANO_10MM_120_SS_C  | 10mm width, strip to strip connector for 120LED/M and more LED, strip      |
|        | 600110020 | KANO_10MM_120_SV_C  | 10mm width, strip to wire connector for 120LED/M and more LED, strip       |
|        | 600110021 | KANO_10MM_120_SSL_C | 10mm width, strip to strip wire connector for 120LED/M and more LED, strip |
|        | 600110022 | KANO_10MM_SS_L_CORN | 10mm width L corner strip to strip connector                               |
|        | 600110023 | KOBE_8MM_SS_C       | Transparent 8mm 240 LED/m and COB LED strip to strip connector             |
|        | 600110024 | KOBE_10MM_SS_C      | Transparent 10mm 240 LED/m and COB LED strip to strip connector            |
|        | 600110025 | KOBE_8MM_SS_L_CORN  | Transparent 8mm 240 LED/m and COB LED L corner strip to strip connector    |
|        | 600110026 | KOBE_10MM_SS_L_CORN | Transparent 10mm 240 LED/m and COB LED L corner strip to strip connector   |
|        | 600110027 | KOBE_8MM_SV_C       | Transparent 8mm 240 LED/m and COB LED strip to wire connector              |
|        | 600110028 | KOBE_10MM_SV_C      | Transparent 10mm 240 LED/m and COB LED strip to wire connector             |
|        | 600110029 | KOBE_8MM_SSL_C      | Transparent 8mm 240 LED/m and COB LED strip to strip wire connector        |
|        | 600110030 | KOBE_10MM_SSL_C     | Transparent 10mm 240 LED/m and COB LED strip to strip wire connector       |

RECESSED LED  
LUMINAIRES

TOPE   
LIGHTING

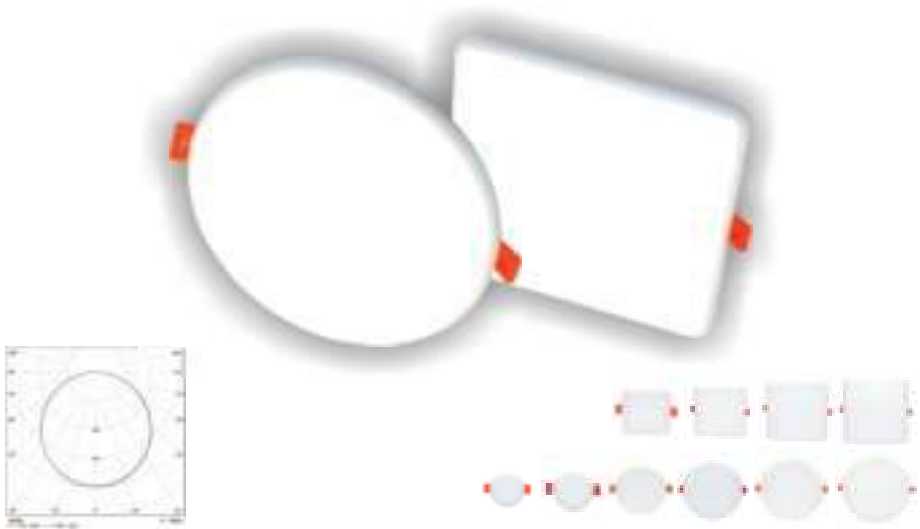

IP65

**IK08**

**CRI≥80**

4000K

WARRANTY

120°

EASY  
INSTALLATION

**SPECIFICATIONS**

- A recessed LED luminaire with a 10 mm no frame profile.
- Electronic, fixed output gear.
- IP65 environmental degree, IK08. Driver IP20, IK03.
- Body: aluminum white painted (RAL9016).
- Diffuser: polycarbonate (PC), UV-stabilised.
- Electrical connection via push wire terminal blocks.
- Complete with 4000K LED.

**MODELS**

| CODE       | MODEL                 | POWER | DIMENSION  | CUT-OUT | LUMEN   |
|------------|-----------------------|-------|------------|---------|---------|
| 6003000042 | ROSA80_6W_R_LED_400   | 6W    | Ø75x24 mm  | Ø45 mm  | 410 lm  |
| 6003000043 | ROSA80_8W_R_LED_580   | 8W    | Ø100x24 mm | Ø75 mm  | 581 lm  |
| 6003000044 | ROSA80_10W_R_LED_800  | 10W   | Ø125x24 mm | Ø100 mm | 830 lm  |
| 6003000045 | ROSA80_14W_R_LED_1110 | 14W   | Ø155x24 mm | Ø125 mm | 1199 lm |
| 6003000046 | ROSA80_20W_R_LED_1740 | 20W   | Ø185x24 mm | Ø164 mm | 1766 lm |
| 6003000047 | ROSA80_28W_R_LED_2270 | 28W   | Ø215x24 mm | Ø192 mm | 2121 lm |

| CODE       | MODEL                 | POWER | DIMENSION     | CUT-OUT | LUMEN   |
|------------|-----------------------|-------|---------------|---------|---------|
| 6003000048 | ROSA80_8W_S_LED_600   | 8W    | 100x100x24 mm | Ø75 mm  | 645 lm  |
| 6003000049 | ROSA80_14W_S_LED_1200 | 14W   | 155x155x24 mm | Ø128 mm | 1228 lm |
| 6003000050 | ROSA80_20W_S_LED_1780 | 20W   | 185x185x24 mm | Ø162 mm | 1790 lm |
| 6003000051 | ROSA80_28W_S_LED_2290 | 28W   | 215x215x24 mm | Ø195 mm | 2299 lm |

## ROSA\_0-10V\_DIMMABLE MODELS







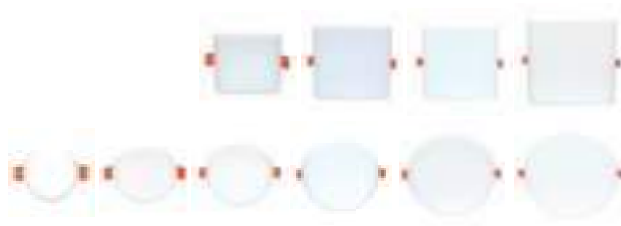
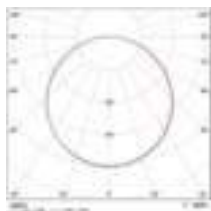
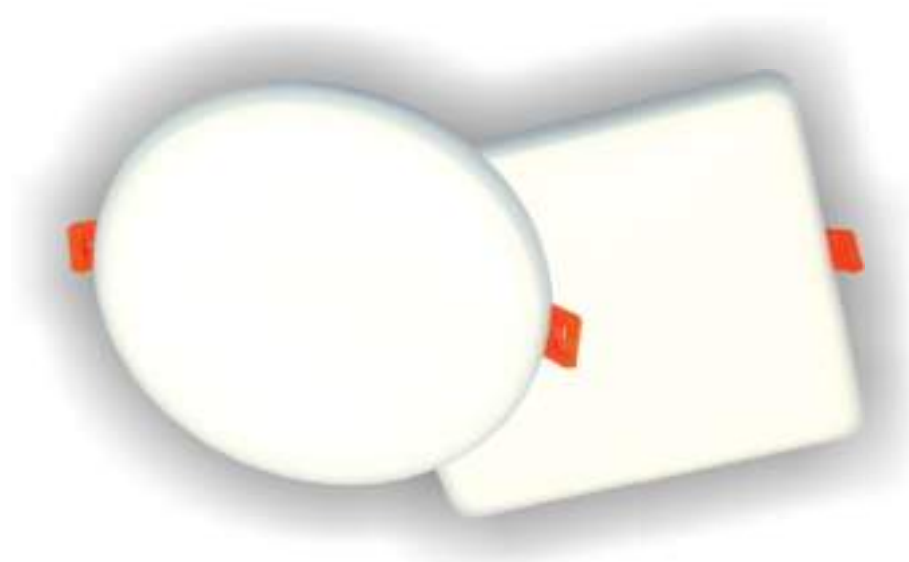

| CODE       | MODEL                       | POWER | DIMENSION     | CUT-OUT | LUMEN   |
|------------|-----------------------------|-------|---------------|---------|---------|
| 6003100042 | ROSA80_6W_R_LED_400_0-10V   | 6 W   | Ø75x24 mm     | Ø45 mm  | 410 lm  |
| 6003100043 | ROSA80_8W_R_LED_580_0-10V   | 8W    | Ø100x24 mm    | Ø75 mm  | 581 lm  |
| 6003100044 | ROSA80_10W_R_LED_800_0-10V  | 10W   | Ø125x24 mm    | Ø100 mm | 830 lm  |
| 6003100045 | ROSA80_14W_R_LED_1110_0-10V | 14W   | Ø155x24 mm    | Ø125 mm | 1199 lm |
| 6003100046 | ROSA80_20W_R_LED_1740_0-10V | 20W   | Ø185x24 mm    | Ø164 mm | 1766 lm |
| 6003100047 | ROSA80_28W_R_LED_2270_0-10V | 28 W  | Ø215x24 mm    | Ø192 mm | 2121 lm |
| CODE       | MODEL                       | POWER | DIMENSION     | CUT-OUT | LUMEN   |
| 6003100048 | ROSA80_8W_S_LED_600_0-10V   | 8W    | 100x100x24 mm | Ø75 mm  | 645 lm  |
| 6003100049 | ROSA80_14W_S_LED_1200_0-10V | 14W   | 155x155x24 mm | Ø128 mm | 1228 lm |
| 6003100050 | ROSA80_20W_S_LED_1780_0-10V | 20W   | 185x185x24 mm | Ø162 mm | 1790 lm |
| 6003100051 | ROSA80_28W_S_LED_2290_0-10V | 28W   | 215x215x24 mm | Ø195 mm | 2299 lm |

## ROSA\_EMERGENCY MODELS



| CODE       | MODEL                    | POWER | DIMENSION     | CUT-OUT | LUMEN   | EM. LUMEN  | EM. WORKING TIME |
|------------|--------------------------|-------|---------------|---------|---------|------------|------------------|
| 6003200043 | ROSA80_8W_R_LED_580_EM   | 8W    | Ø100x24 mm    | Ø75 mm  | 581 lm  | max 315 lm | 2h               |
| 6003200044 | ROSA80_10W_R_LED_800_EM  | 10W   | Ø125x24 mm    | Ø100 mm | 830 lm  | max 331 lm | 2h               |
| 6003200045 | ROSA80_14W_R_LED_1110_EM | 14W   | Ø155x24 mm    | Ø125 mm | 1199 lm | max 345 lm | 2h               |
| 6003200046 | ROSA80_20W_R_LED_1740_EM | 20W   | Ø185x24 mm    | Ø164 mm | 1766 lm | max 390 lm | 2h               |
| 6003200047 | ROSA80_28W_R_LED_2270_EM | 28 W  | Ø215x24 mm    | Ø192 mm | 2121 lm | max 390 lm | 2h               |
| CODE       | MODEL                    | POWER | DIMENSION     | CUT-OUT | LUMEN   | EM. LUMEN  | EM. WORKING TIME |
| 6003200048 | ROSA80_8W_S_LED_600_EM   | 8W    | 100x100x24 mm | Ø75 mm  | 645 lm  | max 351 lm | 2h               |
| 6003200049 | ROSA80_14W_S_LED_1200_EM | 14W   | 155x155x24 mm | Ø128 mm | 1228 lm | max 359 lm | 2h               |
| 6003200050 | ROSA80_20W_S_LED_1780_EM | 20W   | 185x185x24 mm | Ø162 mm | 1790 lm | max 378 lm | 2h               |
| 6003200051 | ROSA80_28W_S_LED_2290_EM | 28W   | 215x215x24 mm | Ø195 mm | 2299 lm | max 378 lm | 2h               |



|  |             |               |   |   |  |   |
|--|-------------|---------------|---|---|--|---|
| <br><b>IP65</b> | <b>IK08</b> | <b>CRI≥80</b> | <br><b>3000K</b> | <br><b>50000 h</b> | <br><b>WARRANTY</b> | <br><b>120°</b> |
|--|-------------|---------------|---|---|--|---|

**SPECIFICATIONS**

- A recessed LED luminaire with a 10 mm no frame profile.
- Electronic, fixed output gear.
- IP65 environmental degree, IK08. Driver IP20, IK03.
- Body: aluminum white painted (RAL9016).
- Diffuser: polycarbonate (PC), UV-stabilised.
- Electrical connection via push wire terminal blocks.
- Complete with 3000K LED.



## RONDA\_ROUND\_SQUARE MODELS



| CODE       | MODEL                  | POWER | DIMENSION  | CUT-OUT | LUMEN   |
|------------|------------------------|-------|------------|---------|---------|
| 6003000031 | RONDA80_R_6W_LED_400   | 6W    | Ø75x25 mm  | Ø50 mm  | 409 lm  |
| 6003000032 | RONDA80_R_8W_LED_580   | 8W    | Ø100x25 mm | Ø80 mm  | 580 lm  |
| 6003000033 | RONDA80_R_10W_LED_800  | 10W   | Ø125x25 mm | Ø105 mm | 829 lm  |
| 6003000034 | RONDA80_R_14W_LED_1110 | 14W   | Ø155x25 mm | Ø130 mm | 1199 lm |
| 6003000035 | RONDA80_R_20W_LED_1740 | 20W   | Ø185x25 mm | Ø168 mm | 1766 lm |
| 6003000036 | RONDA80_R_28W_LED_2270 | 28W   | Ø215x25 mm | Ø195 mm | 2121 lm |

| CODE       | MODEL                  | POWER | DIMENSION     | CUT-OUT | LUMEN   |
|------------|------------------------|-------|---------------|---------|---------|
| 6003000037 | RONDA80_S_8W_LED_530   | 8W    | 100x100x25 mm | Ø80 mm  | 645 lm  |
| 6003000038 | RONDA80_S_14W_LED_1000 | 14W   | 155x155x25 mm | Ø125 mm | 1228lm  |
| 6003000039 | RONDA80_S_20W_LED_1520 | 20W   | 185x185x25 mm | Ø160 mm | 1790 lm |
| 6003000040 | RONDA80_S_28W_LED_2050 | 28W   | 217x217x25 mm | Ø195 mm | 2299 lm |

## RONDA\_0-10V\_DIMMABLE MODELS



| CODE       | MODEL                        | POWER | DIMENSION  | CUT-OUT | LUMEN   |
|------------|------------------------------|-------|------------|---------|---------|
| 6003100031 | RONDA80_R_6W_LED_400_0-10V   | 6W    | Ø75x25 mm  | Ø50 mm  | 409 lm  |
| 6003100032 | RONDA80_R_8W_LED_5800_0-10V  | 8W    | Ø100x25 mm | Ø80 mm  | 580 lm  |
| 6003100033 | RONDA80_R_10W_LED_800_0-10V  | 10W   | Ø125x25 mm | Ø105 mm | 829 lm  |
| 6003100034 | RONDA80_R_14W_LED_1110_0-10V | 14W   | Ø155x25 mm | Ø130 mm | 1199 lm |
| 6003100035 | RONDA80_R_20W_LED_1740_0-10V | 20W   | Ø185x25 mm | Ø168 mm | 1766 lm |

| CODE       | MODEL                         | POWER | DIMENSION     | CUT-OUT | LUMEN   |
|------------|-------------------------------|-------|---------------|---------|---------|
| 6003100037 | RONDA80_S_8W_LED_5300_0-10V   | 8W    | 100x100x25 mm | Ø80 mm  | 645 lm  |
| 6003100038 | RONDA80_S_14W_LED_10000_0-10V | 14W   | 155x155x25 mm | Ø125 mm | 1228lm  |
| 6003100039 | RONDA80_S_20W_LED_1520_0-10V  | 20W   | 185x185x25 mm | Ø160 mm | 1790 lm |

ROSA

RONDA



| CODE       | MODEL                              | DIMENSION    |
|------------|------------------------------------|--------------|
| 6003500044 | Plastic Surface mounted plate R155 | Ø154.5x37 mm |
| 6003500046 | Plastic Surface mounted plate R185 | Ø184.5x37 mm |
| 6003500047 | Plastic Surface mounted plate R215 | Ø214.5x37 mm |



IP44
IK05
CRI≥80
4000K
50000 h
3 WARRANTY
EASY INSTALLATION

**SPECIFICATIONS**

- A recessed LED luminaire with a 7 mm profile.
- Electronic, fixed output gear.
- IP44 protection degree. IK05.
- Body: sheet aluminum white (RAL9016). Diffuser: polycarbonate (PC), UV-stabilised.
- Electrical connection via push wire terminal blocks. With integrated driver.
- Complete with 4000K LED.

**MODELS**

| CODE       | MODEL                  | POWER | DIMENSION  | CUT-OUT | LUMEN   |
|------------|------------------------|-------|------------|---------|---------|
| 6003000017 | SPLIT80_R_5W_LED_355   | 5W    | Ø75x30 mm  | Ø71 mm  | 325 lm  |
| 6003000018 | SPLIT80_R_8W_LED_570   | 8W    | Ø93x30 mm  | Ø72 mm  | 461 lm  |
| 6003000020 | SPLIT80_R_16W_LED_1280 | 16W   | Ø150x30 mm | Ø130 mm | 1168 lm |
| 6003000021 | SPLIT80_R_22W_LED_1760 | 22W   | Ø175x30 mm | Ø153 mm | 1772 lm |
| 6003000022 | SPLIT80_R_30W_LED_2400 | 30W   | Ø225x30 mm | Ø195 mm | 2147 lm |

| CODE       | MODEL                  | POWER | DIMENSION     | CUT-OUT    | LUMEN   |
|------------|------------------------|-------|---------------|------------|---------|
| 6003000023 | SPLIT80_S_5W_LED_355   | 5W    | 75x75x30 mm   | 61x61 mm   | 325 lm  |
| 6003000024 | SPLIT80_S_8W_LED_570   | 8W    | 85x85x30 mm   | 75x75 mm   | 461 lm  |
| 6003000026 | SPLIT80_S_16W_LED_1280 | 16 W  | 142x142x30 mm | 127x127 mm | 1168 lm |
| 6003000027 | SPLIT80_S_22W_LED_1760 | 22W   | 168x168x30 mm | 155x155 mm | 1772 lm |
| 6003000028 | SPLIT80_S_30W_LED_2400 | 30W   | 223x223x30 mm | 196x196 mm | 2147 lm |

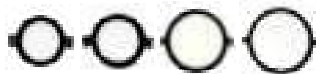
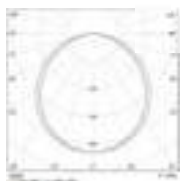

## SPECIFICATIONS

- A recessed LED luminaire with a 7 mm profile.
- Electronic, fixed output gear.
- IP44 protection degree. IK05.
- Body: sheet aluminum black (RAL 9005). Diffuser: polycarbonate (PC), UV-stabilised.
- Electrical connection via push wire terminal blocks. With integrated driver.
- Complete with 3000K LED.

## MODELS

| CODE       | MODEL                    | POWER | DIMENSION  | CUT-OUT | LUMEN   |
|------------|--------------------------|-------|------------|---------|---------|
| 6003000080 | SPLIT80_R_5W_B_LED_355   | 5W    | Ø75x30 mm  | Ø71 mm  | 325 lm  |
| 6003000081 | SPLIT80_R_8W_B_LED_570   | 8W    | Ø93x30 mm  | Ø72 mm  | 461 lm  |
| 6003000082 | SPLIT80_R_16W_B_LED_1280 | 16W   | Ø150x30 mm | Ø130 mm | 1168 lm |
| 6003000083 | SPLIT80_R_22W_B_LED_1760 | 22W   | Ø175x30 mm | Ø153 mm | 1772 lm |



**SPECIFICATIONS**

- A recessed LED luminaire with a slim 1,5 mm profile.
- Electronic, fixed output gear.
- IP40 from below, IP20 from above, IK05.
- Body: aluminum white (RAL9016). Diffuser: polycarbonate (PC), UV-stabilised.
- Electrical connection via terminal blocks.
- Complete with 3000K LED.

**MODELS**

| CODE       | MODEL                 | POWER | DIMENSION    | CUT-OUT | LUMEN   |
|------------|-----------------------|-------|--------------|---------|---------|
| 6003000001 | AIRA75_R_3W_LED_225   | 3W    | Ø85x20 mm    | Ø70 mm  | 270 lm  |
| 6003000002 | AIRA75_R_6W_LED_450   | 6W    | Ø120 x 20 mm | Ø107 mm | 551 lm  |
| 6003000003 | AIRA75_R_12W_LED_900  | 12W   | Ø170 x 20 mm | Ø155 mm | 933 lm  |
| 6003000004 | AIRA75_R_18W_LED_1800 | 18W   | Ø220 x 20 mm | Ø205 mm | 1289 lm |
| 6003000005 | AIRA75_R_24W_LED_1800 | 24W   | Ø295 x 20 mm | Ø282 mm | 1517 lm |

| CODE       | MODEL                 | POWER | DIMENSION     | CUT-OUT    | LUMEN   |
|------------|-----------------------|-------|---------------|------------|---------|
| 6003000006 | AIRA75_S_3W_LED_225   | 3W    | 85x85x20 mm   | 70x70 mm   | 270 lm  |
| 6003000007 | AIRA75_S_6W_LED_450   | 6W    | 120x120x20 mm | 105x105 mm | 551 lm  |
| 6003000008 | AIRA75_S_12W_LED_900  | 12W   | 165x165x25 mm | 152x152 mm | 933 lm  |
| 6003000009 | AIRA75_S_18W_LED_1350 | 18W   | 220x220x25 mm | 205x205 mm | 1289 lm |
| 6003000010 | AIRA75_S_24W_LED_1800 | 24W   | 300x300x25 mm | 275x275 mm | 1517 lm |



**SPECIFICATIONS**

- Recessed LED downlight. Constant power electronic power supply.
- IP40 from below, IP20 from above. IK05 impact resistance.
- Housing aluminum with stainless steel insert. A rear mounted cooler.
- Tilts up to 30° with locking function.
- Complete with 3000K LED.



30°



CE

RoHS



IP40

IK05

CRI≥70



3000K



30000 h



3  
WARRANTY

**MODELS**

| CODE       | MODEL               | POWER | DIMENSION  | CUT-OUT | LUMEN  |
|------------|---------------------|-------|------------|---------|--------|
| 6005000001 | LENS70_3W_R_LED_210 | 3W    | Ø85x40 mm  | Ø70 mm  | 209 lm |
| 6005000002 | LENS70_5W_R_LED_350 | 5W    | Ø110x40 mm | Ø90 mm  | 351 lm |

| CODE       | MODEL                | POWER | DIMENSION     | CUT-OUT | LUMEN  |
|------------|----------------------|-------|---------------|---------|--------|
| 6005000010 | LENS70_3W_SQ_LED_210 | 3W    | 111X93x45 mm  | Ø70 mm  | 209 lm |
| 6005000011 | LENS70_5W_SQ_LED_350 | 5W    | 135X120x45 mm | Ø90 mm  | 351 lm |



### SPECIFICATIONS

- Recessed LED downlight.
- Constant power electronic power supply.
- IP40 from below, IP20 from above. Impact resistant IK05.
- Housing aluminum painted with white (RAL 9016) powder coating.
- A cooler is installed at the back of the luminaire.
- Complete with 3000K LED.



### MODELS

| CODE      | MODEL               | POWER | DIMENSION  | CUT-OUT | LUMEN  |
|-----------|---------------------|-------|------------|---------|--------|
| 600500003 | ANDA70_3W_R_LED_210 | 3W    | Ø85x53 mm  | Ø65 mm  | 209 lm |
| 600500004 | ANDA70_5W_R_LED_350 | 5W    | Ø108x50 mm | Ø85 mm  | 351 lm |

CEILING LED  
LUMINAIRES



TOPE   
LIGHTING





## SPECIFICATIONS

- A surfaced /suspended with mounting cables (max 1 m long) LED luminaire with 80 mm profile.
- Electronic fixed output gear, IP20, IK05.
- Body: steel, black, white. Diffuser: Acrylic, UV-stabilised.
- Electrical connection via push wire terminal blocks.
- Complete with 3000K/4000K/6500K LED. There is option to change CCT by dip switch.



## MODELS

| CODE      | MODEL                    | POWER | DIMENSION  | LUMEN   | HOUSING COLOR |
|-----------|--------------------------|-------|------------|---------|---------------|
| 600400087 | MEKA90_SU_W_30W_LED_2700 | 30W   | Ø500x80 mm | 2700 lm | White         |
| 600400088 | MEKA90_SU_W_36W_LED_3240 | 36W   | Ø600x80 mm | 3240 lm | White         |
| 600400089 | MEKA90_SU_W_48W_LED_4320 | 48W   | Ø800x80 mm | 4320 lm | White         |
| 600400090 | MEKA90_SU_B_30W_LED_2700 | 30W   | Ø500x80 mm | 2700 lm | Black         |
| 600400091 | MEKA90_SU_B_36W_LED_3240 | 36W   | Ø600x80 mm | 3240 lm | Black         |
| 600400092 | MEKA90_SU_B_48W_LED_4320 | 48W   | Ø800x80 mm | 4320 lm | Black         |

## FINISH





**SPECIFICATIONS**

- A surfaced /suspended with mounting cables (max 1 m long) LED luminaire with 100 mm profile.
- Electronic, fixed output control gear. IP20. Body: steel.
- Diffuser: acrylic. Connection via push wire terminal blocks.
- Supplied with adjustable wire suspended mounting and cables.
- Complete with 3000K/4000K/6500K LED. There is option to change CCT by dip switch.

|             |             |             |               |                              |                |                 |
|-------------|-------------|-------------|---------------|------------------------------|----------------|-----------------|
| <b>RoHS</b> | <b>IP20</b> | <b>IK05</b> | <b>CRI≥80</b> | <b>3000K</b><br><b>6500K</b> | <b>50000 h</b> | <b>WARRANTY</b> |
|-------------|-------------|-------------|---------------|------------------------------|----------------|-----------------|

**MODELS**

| CODE       | MODEL                    | POWER | DIMENSION   | LUMEN   | HOUSING COLOR |
|------------|--------------------------|-------|-------------|---------|---------------|
| 6004000029 | MORA95_SU_W_40W_LED_3800 | 40W   | Ø500x100 mm | 3837 lm | White         |
| 6004000030 | MORA95_SU_W_60W_LED_5700 | 60W   | Ø600x100 mm | 5811 lm | White         |
| 6004000031 | MORA95_SU_W_70W_LED_6650 | 70W   | Ø800x100 mm | 8699 lm | White         |
| 6004000032 | MORA95_SU_B_40W_LED_3800 | 40W   | Ø500x100 mm | 3837 lm | Black         |
| 6004000033 | MORA95_SU_B_60W_LED_5700 | 60W   | Ø600x100 mm | 5811 lm | Black         |
| 6004000034 | MORA95_SU_B_70W_LED_6650 | 70W   | Ø800x100 mm | 8699 lm | Black         |

**FINISH**



## MORA\_0-10V\_DIMMABLE



### MODELS

| CODE       | MODEL                               | POWER | DIMENSION   | LUMEN   | HOUSING COLOR |
|------------|-------------------------------------|-------|-------------|---------|---------------|
| 6004100031 | MORA95_SU_W_70W_LED_6650_0-10V_DIM  | 70W   | Ø800x100 mm | 8699 lm | White         |
| 6004100034 | MORA_95_SU_B_70W_LED_6650_0-10V_DIM | 70W   | Ø800x100 mm | 8699 lm | Black         |

## MORA\_TRIAC\_DIMMABLE



### MODELS

| CODE       | MODEL                          | POWER | DIMENSION   | LUMEN   | HOUSING COLOR |
|------------|--------------------------------|-------|-------------|---------|---------------|
| 6004300029 | MORA95_SU_W_40W_LED_3800_TRIAC | 40W   | Ø500x100 mm | 3837 lm | White         |
| 6004300031 | MORA95_SU_W_70W_LED_6650_TRIAC | 70W   | Ø800x100 mm | 8699 lm | White         |
| 6004300032 | MORA95_SU_B_40W_LED_3800_TRIAC | 40W   | Ø500x100 mm | 3837 lm | Black         |
| 6004300034 | MORA95_SU_B_70W_LED_6650_TRIAC | 70W   | Ø800x100 mm | 8699 lm | Black         |

## MORA\_REMOTE CONTROL



### MODELS

| CODE       | MODEL                               | POWER | DIMENSION   | LUMEN   | HOUSING COLOR |
|------------|-------------------------------------|-------|-------------|---------|---------------|
| 6004600029 | MORA95_SU_W_40W_LED_3800_REM.CONTR. | 40W   | Ø500x100 mm | 3837 lm | White         |
| 6004600031 | MORA95_SU_W_70W_LED_6650_REM.CONTR. | 70W   | Ø800x100 mm | 8699 lm | White         |
| 6004600032 | MORA95_SU_B_40W_LED_3800_REM.CONTR. | 40W   | Ø500x100 mm | 3837 lm | Black         |
| 6004600034 | MORA95_SU_B_70W_LED_6650_REM.CONTR. | 70W   | Ø800x100 mm | 8699 lm | Black         |

## MORA\_EMERGENCY



### MODELS

| CODE       | MODEL                      | POWER | DIMENSION   | LUMEN   | EM. LUMEN  | EM. WORKING TIME | HOUSING COLOR |
|------------|----------------------------|-------|-------------|---------|------------|------------------|---------------|
| 6004200030 | MORA95_SU_W_60W_LED_5700EM | 60 W  | Ø600x100 mm | 5811 lm | max 425 lm | 2h               | White         |
| 6004200031 | MORA95_SU_W_70W_LED_6650EM | 70W   | Ø800x100 mm | 8699 lm | max 438 lm | 2h               | White         |
| 6004200033 | MORA95_SU_B_60W_LED_5700EM | 60W   | Ø600x100 mm | 5811 lm | max 425 lm | 2h               | Black         |
| 6004200034 | MORA95_SU_B_70W_LED_6650EM | 70W   | Ø800x100 mm | 8699 lm | max 438 lm | 2h               | Black         |



## SPECIFICATIONS

- Contemporary dome shaped surfaced LED luminaire.
- Electronic, fixed output control gear. Bezel in white.
- Diffuser: Polycarbonate (PC). IP54.
- Complete with 3000/4000/6000K LED, adjustable by wall swith with memory function.

## MODELS

| CODE       | MODEL               | POWER | DIMENSION   | LUMEN   |
|------------|---------------------|-------|-------------|---------|
| 6004000144 | SORA85_12W_LED_1020 | 12W   | Ø 230x30 mm | 1020 lm |
| 6004000145 | SORA85_18W_LED_1530 | 18W   | Ø 280x30 mm | 1530 lm |
| 6004000146 | SORA85_28W_LED_2380 | 28W   | Ø 380x40 mm | 2380 lm |
| 6004000147 | SORA85_45W_LED_3825 | 45W   | Ø 480x40 mm | 3825 lm |

- Microwave sensor maximum height 3.5 m.  
Workplane 360°, 10m from sensor. Working time 30s.

## SORA\_SENS

## MODELS

| CODE       | MODEL                 | POWER | DIMENSION   | LUMEN   |
|------------|-----------------------|-------|-------------|---------|
| 6004000148 | SORASENS_18W_LED_1530 | 18W   | Ø 280x30 mm | 1530 lm |
| 6004000149 | SORASENS_28W_LED_2380 | 28W   | Ø 380x40 mm | 2380 lm |



## SPECIFICATIONS

- A compact, round luminaire with LED package.
- Electronic, fixed output control gear. IP54. Body: white polycarbonat. Diffuser: opal polycarbonat.
- Supplied with Quick Fix Bracket. Mains connection via push wire terminal for wire up to 2.5 mm<sup>2</sup>.
- Complete with 3000K to 6000K LED, adjustable by switch on backside of the luminaire.



## MODELS

| CODE      | MODEL                        | POWER | DIMENSION  | LUMEN   | MODIFICATION |
|-----------|------------------------------|-------|------------|---------|--------------|
| 600400093 | RIGASENS110_18W_CCT_LED_1900 | 18W   | Ø240x40 mm | 1890 lm | with sensor  |
| 600400094 | RIGA110_18W_CCT_LED_1900     | 18W   | Ø240x40 mm | 1890 lm | -            |
| 600400095 | RIGA110_24W_CCT_LED_2600     | 24W   | Ø290x40 mm | 2520 lm | -            |



  
 IP54

IK08

CRI≥80

$\frac{3000K}{6000K}$

  
 30000 h

  
 WARRANTY

  
 EASY  
 INSTALLATION

**SPECIFICATIONS**

- Contemporary dome shaped surfaced LED luminaire.
- Electronic, fixed output control gear. Bezel in white.
- Diffuser: Polycarbonate (PC). IP54.
- Ceiling or wall mounting via 2 fixing holes.
- Complete with microwave sensor and 3000/4000/6000K LED. There is option to change CCT by dip switch.

**MODELS**

| CODE       | MODEL                | POWER | DIMENSION  | LUMEN   |
|------------|----------------------|-------|------------|---------|
| 6004000076 | RIO_15W_CCT_LED_1350 | 15W   | Ø220x50 mm | 1358 lm |
| 6004000077 | RIO_18W_CCT_LED_1620 | 18W   | Ø280x50 mm | 1627 lm |

- Microwave sensor maximum height 3.5 m. Workplane 360°, 10m from sensor. Working time 30s.

**RIO\_SENS**

**MODELS**

  
 SENSOR

  
 IP54

IK08

CRI≥80

$\frac{3000K}{6000K}$

  
 WARRANTY

  
 EASY  
 INSTALLATION

| CODE       | MODEL                    | POWER | DIMENSION  | LUMEN   |
|------------|--------------------------|-------|------------|---------|
| 6004000078 | RIOSENS_15W_CCT_LED_1350 | 15W   | Ø220x50 mm | 1358 lm |
| 6004000079 | RIOSENS_18W_CCT_LED_1620 | 18W   | Ø280x50 mm | 1627 lm |

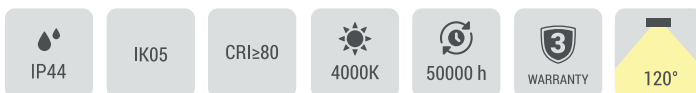

**SPECIFICATIONS**

- Surface LED luminaire with a 31 mm profile.
- Electronic, fixed output gear. IP44 protection degree. IK05.
- Body: sheet aluminum, white (RAL9016). Diffuser: polycarbonate (PC), UV-stabilised.
- Electrical connection via push wire terminal blocks.
- Complete with 4000K LED.

**MODELS**

| CODE       | MODEL                   | POWER | DIMENSION  | LUMEN   |
|------------|-------------------------|-------|------------|---------|
| 6004000017 | MODENA80_R_8W_LED_570   | 8W    | Ø97x31 mm  | 461 lm  |
| 6004000019 | MODENA80_R_16W_LED_1140 | 16W   | Ø157x31 mm | 1168 lm |
| 6004000020 | MODENA80_R_22W_LED_1570 | 22W   | Ø180x31 mm | 1772 lm |
| 6004000021 | MODENA80_R_30W_LED_2150 | 30W   | Ø230x31 mm | 2147 lm |

| CODE       | MODEL                   | POWER | DIMENSION     | LUMEN   |
|------------|-------------------------|-------|---------------|---------|
| 6004000022 | MODENA80_S_8W_LED_570   | 8W    | 90x90x31 mm   | 461 lm  |
| 6004000024 | MODENA80_S_16W_LED_1140 | 16W   | 145x145x31 mm | 1168 lm |
| 6004000025 | MODENA80_S_22W_LED_1570 | 22W   | 171x171x31 mm | 1772 lm |
| 6004000026 | MODENA80_S_30W_LED_2150 | 30W   | 222x222x31 mm | 2147 lm |

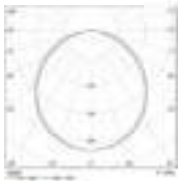

**SPECIFICATIONS**

- Surface LED luminaire with a 31 mm profile.
- Electronic, fixed output gear. IP44 protection degree. IK05.
- Body: sheet aluminum, black (RAL 9005). Diffuser: polycarbonate (PC), UV-stabilised.
- Electrical connection via push wire terminal blocks.
- Complete with 3000K LED.

**MODELS**

| CODE       | MODEL                     | POWER | DIMENSION  | LUMEN   |
|------------|---------------------------|-------|------------|---------|
| 6004000150 | MODENA80_R_16W_B_LED_1140 | 16W   | Ø157x31 mm | 1168 lm |
| 6004000151 | MODENA80_R_22W_B_LED_1570 | 22W   | Ø180x31 mm | 1772 lm |
| 6004000152 | MODENA80_R_30W_B_LED_2150 | 30W   | Ø230x31 mm | 2147 lm |





## SPECIFICATIONS

- Surface LED luminaire, with a 55mm profile.
- Electronic, fixed output gear. IP40 protection degree. IK05.
- Body: sheet steel white (RAL9016). Diffuser: Polycarbonate, UV-stabilised.
- Electrical connection via terminal blocks.
- Complete with 3000K LED.

## MODELS

| CODE       | MODEL                    | POWER | DIMENSION     | LUMEN  |
|------------|--------------------------|-------|---------------|--------|
| 6004000047 | TORA75_SU_R_6W_LED_450   | 6W    | Ø91x55 mm     | 409lm  |
| 6004000048 | TORA75_SU_R_12W_LED_900  | 12W   | Ø120x55 mm    | 852lm  |
| 6004000049 | TORA75_SU_R_18W_LED_1350 | 18W   | Ø185x55 mm    | 1265lm |
| 6004000050 | TORA75_SU_R_24W_LED_1800 | 24W   | Ø225x55 mm    | 1685lm |
| CODE       | MODEL                    | POWER | DIMENSION     | LUMEN  |
| 6004000051 | TORA75_SU_R_6W_LED_450   | 6W    | 91x91x55 mm   | 409lm  |
| 6004000052 | TORA75_SU_R_12W_LED_900  | 12W   | 121x121x55 mm | 852lm  |
| 6004000053 | TORA75_SU_R_18W_LED_1350 | 18W   | 184x184x55 mm | 1265lm |
| 6004000054 | TORA75_SU_R_24W_LED_1800 | 24W   | 225x225x55 mm | 1685lm |





LED SMART  
LIGHTING

TOPE &  
LIGHTING



  
 SMART  
LIGHTING

  
 REMOTE



  
 IP20

IK05

CRI≥80

3000K  
6500K

**SPECIFICATIONS**

- A versatile, circular luminaire for surface mounting, with the option of choosing a color temperature from 3000 to 6500K.
- Electronic output control gear. IP20, IK05. Diffuser: acrylic.
- Body: steel white (RAL 9016). Diffuser: acrylic opal.
- Connection via push wire terminal blocks.
- Supplied with remote for dimming and CCT changing.
- Adjustment can be made by app as well.
- 3000 to 6500K LED CCT adjustable.

**MODELS**

| CODE       | MODEL                    | POWER | DIMENSION  | LUMEN        |
|------------|--------------------------|-------|------------|--------------|
| 6004000153 | BOLTON100_36W_W_LED_3600 | 2x36W | Ø450x50 mm | 5681 lm Max  |
| 6004000154 | BOLTON100_48W_W_LED_4800 | 2x48W | Ø600x50 mm | 8563 lm Max  |
| 6004000155 | BOLTON100_60W_W_LED_6000 | 2x60W | Ø800x50 mm | 10771 lm Max |
| 6004000156 | BOLTON100_36W_B_LED_3600 | 2x36W | Ø450x50 mm | 5681 lm Max  |
| 6004000157 | BOLTON100_48W_B_LED_4800 | 2x48W | Ø600x50 mm | 8563 lm Max  |
| 6004000158 | BOLTON100_60W_B_LED_6000 | 2x60W | Ø800x50 mm | 10771 lm Max |

**FINISH**

- BLACK
  WHITE





SMART  
LIGHTING



REMOTE





IP20

IK05

CRI≥80

3000K  
6500K

**SPECIFICATIONS**

- A versatile, circular luminaire for surface mounting, with the option of choosing a color temperature from 3000 to 6500K.
- Electronic output control gear. IP20, IK05. Diffuser: acrylic.
- Body: steel white (RAL 9016). Diffuser: acrylic opal.
- Connection via push wire terminal blocks.
- Supplied with remote for dimming and CCT changing.
- Adjustment can be made by app as well.
- 3000 to 6500K LED CCT adjustable.

**MODELS**

| CODE      | MODEL                     | POWER | DIMENSION  | LUMEN        |
|-----------|---------------------------|-------|------------|--------------|
| 600400082 | BOSTON90_W_2X36W_LED_5400 | 2x36W | ∅450x50 mm | 5681 lm Max  |
| 600400081 | BOSTON90_W_2x48W_LED_7200 | 2x48W | ∅600x50 mm | 8563 lm Max  |
| 600400083 | BOSTON90_W_2X60W_LED_8400 | 2x60W | ∅800x50 mm | 10771 lm Max |
| 600400084 | BOSTON90_B_2X36W_LED_5400 | 2x36W | ∅450x50 mm | 5681 lm Max  |
| 600400085 | BOSTON90_B_2X48W_LED_7200 | 2x48W | ∅600x50 mm | 8563 lm Max  |
| 600400086 | BOSTON90_B_2X60W_LED_8400 | 2x60W | ∅800x50 mm | 10771 lm Max |

**FINISH**

- BLACK   ○ WHITE

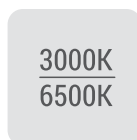
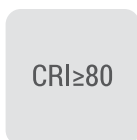
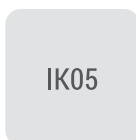
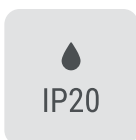

**SPECIFICATIONS**

- Surfaced LED luminaire.
- Electronic, Infrared wireless dimmable, CCT adjustable output control gear.
- Body: white painted steel. Diffuser: Polycarbonate (PC), IP20.
- The luminaire is controlled by remote, which included to the set.
- 3000 to 6500K CCT adjustable.

**MODELS**

| CODE       | MODEL                | POWER | DIMENSION  | LUMEN   |
|------------|----------------------|-------|------------|---------|
| 6004000055 | SOPOT_2x18W_LED_3320 | 2x18W | Ø325x65 mm | 3318 lm |
| 6004000056 | SOPOT_2x24W_LED_4470 | 2x24W | Ø380x70 mm | 4464 lm |
| 6004000057 | SOPOT_2x36W_LED_6740 | 2x36W | Ø475x70 mm | 6732 lm |
| 6004000058 | SOPOT_2x48W_LED_9030 | 2x48W | Ø585x75 mm | 9027 lm |

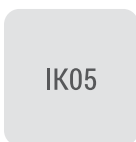
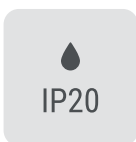

**SPECIFICATIONS**

- Surfaced LED luminaire.
- Electronic, Infrared wireless dimmable, CCT adjustable output control gear.
- Body: white painted steel. Diffuser: Polycarbonate (PC), IP20.
- The luminaire is controlled by remote, which included to the set.
- 3000 to 6500K CCT adjustable.

**MODELS**

| CODE       | MODEL                  | POWER  | DIMENSION     | LUMEN   |
|------------|------------------------|--------|---------------|---------|
| 6004000074 | SOPOT_2x24W_S_LED_4470 | 2x24W  | 380x380x65 mm | 4464 lm |
| 6004000075 | SOPOT_2x36W_S_LED_6740 | 2x36 W | 475x475x60 mm | 6732 lm |



LED  
PANELS

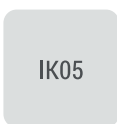
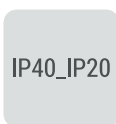

## SPECIFICATIONS

- A recessed/surfaced/suspended with mounting cables LED luminaire with a 9/35 mm profile, 35 mm height.
- Electronic fixed output gear. IP44 from below, IP40\_IP20 from above, IK05.
- Body: sheet steel white (RAL9016). Diffuser: polycarbonate (PC), UV-stabilised.
- With UGR < 19. Complete with 4000K.

## MODELS

| CODE       | MODEL                   | POWER | DIMENSION     | LUMEN  | KELVIN |
|------------|-------------------------|-------|---------------|--------|--------|
| 6003000085 | MESA160_27W_4K_UGR_3563 | 27W   | 595x595x35 mm | 3563lm | 4000K  |



### MESA\_27W\_UGR<19\_0-10V\_DIMMABLE

- Dimmable: 0-10V



#### MODELS

| CODE       | MODEL                         | POWER | DIMENSION     | LUMEN  | KELVIN |
|------------|-------------------------------|-------|---------------|--------|--------|
| 6003100085 | MESA160_27W_4K_UGR_3563_0-10V | 27W   | 595x595x35 mm | 3563lm | 4000K  |

### MESA\_27W\_UGR<19\_DALI

- With DALI.



#### MODELS

| CODE       | MODEL                        | POWER | DIMENSION     | LUMEN  | KELVIN |
|------------|------------------------------|-------|---------------|--------|--------|
| 6003400085 | MESA160_27W_4K_UGR_3563_DALI | 27W   | 595x595x35 mm | 3563lm | 4000K  |

### MESA\_27W\_UGR<19\_EMERGENCY

- With emergency block. Working time 2h.



#### MODELS

| CODE       | MODEL                      | POWER | DIMENSION     | LUMEN  | EM. WORKING TIME | KELVIN |       |
|------------|----------------------------|-------|---------------|--------|------------------|--------|-------|
| 6003200085 | MESA160_27W_4K_UGR_3563_EM | 27W   | 595x595x35 mm | 3563lm | max 457 lm       | 2h     | 4000K |

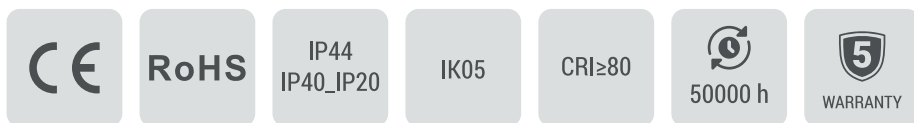

**SPECIFICATIONS**

- A recessed/surfaced/suspended with mounting cables LED luminaire with a 9/35 mm profile, 35 mm height.
- Electronic fixed output gear. IP44 from below, IP40\_IP20 from above, IK05.
- Body: sheet steel white (RAL9016). Diffuser: polycarbonate (PC), UV-stabilised.
- Complete with 4000K.

**MODELS**

| CODE       | MODEL                   | POWER | DIMENSION     | LUMEN  | KELVIN |
|------------|-------------------------|-------|---------------|--------|--------|
| 6003000084 | MESA160_27W_4K_LED_4315 | 27W   | 595x595x35 mm | 4315lm | 4000K  |

### MESA\_27W\_0-10V\_DIMMABLE

- Dimmable: 0-10V



#### MODELS

| CODE       | MODEL                         | POWER | DIMENSION     | LUMEN  | KELVIN |
|------------|-------------------------------|-------|---------------|--------|--------|
| 6003100084 | MESA160_27W_4K_LED_4315_0-10V | 27W   | 595x595x35 mm | 4315lm | 4000K  |

### MESA\_27W\_DALI

- With DALI.



#### MODELS

| CODE       | MODEL                        | POWER | DIMENSION     | LUMEN  | KELVIN |
|------------|------------------------------|-------|---------------|--------|--------|
| 6003400084 | MESA160_27W_4K_LED_4315_DALI | 27W   | 595x595x35 mm | 4315lm | 4000K  |

### MESA\_27W\_EMERGENCY

- With emergency block. Working time 2h.



#### MODELS

| CODE       | MODEL                      | POWER | DIMENSION     | LUMEN  | EM. LUMEN  | EM. WORKING TIME | KELVIN |
|------------|----------------------------|-------|---------------|--------|------------|------------------|--------|
| 6003200084 | MESA160_27W_4K_LED_4315_EM | 27W   | 595x595x35 mm | 4315lm | max 457 lm | 2h               | 4000K  |

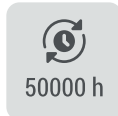
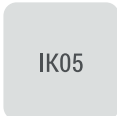
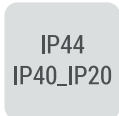

## SPECIFICATIONS

- A recessed/surfaced/suspended with mounting cables LED luminaire with a 9/35 mm profile, 35 mm height.
- Electronic fixed output gear. IP44 from below, IP40\_IP20 from above, IK05.
- Body: sheet steel white (RAL9016). Diffuser: polycarbonate (PC), UV-stabilised.
- With UGR < 19. Complete with 3000K, 4000K.

## MODELS

| CODE       | MODEL                   | POWER | DIMENSION     | LUMEN  | KELVIN |
|------------|-------------------------|-------|---------------|--------|--------|
| 6003000078 | MESA100_42W_3K_UGR_3877 | 42W   | 595x595x35 mm | 3877lm | 3000K  |
| 6003000079 | MESA100_42W_4K_UGR_3982 | 42W   | 595x595x35 mm | 3982lm | 4000K  |

### MESA\_UGR<19\_0-10V\_DIMMABLE

- Dimmable: 0-10V



#### MODELS

| CODE       | MODEL                         | POWER | DIMENSION     | LUMEN  | KELVIN |
|------------|-------------------------------|-------|---------------|--------|--------|
| 6003100078 | MESA100_42W_3K_UGR_3877_0-10V | 42W   | 595x595x35 mm | 3877lm | 3000K  |
| 6003100079 | MESA100_42W_4K_UGR_3982_0-10V | 42W   | 595x595x35 mm | 3982lm | 4000K  |

### MESA\_UGR<19\_TRIAC\_DIMMABLE

- Dimmable: TRIAC.

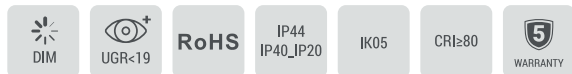

#### MODELS

| CODE       | MODEL                         | POWER | DIMENSION     | LUMEN  | KELVIN |
|------------|-------------------------------|-------|---------------|--------|--------|
| 6003300078 | MESA100_42W_3K_UGR_3877_TRIAC | 42W   | 595x595x35 mm | 3877lm | 3000K  |
| 6003300079 | MESA100_42W_4K_UGR_3982_TRIAC | 42W   | 595x595x35 mm | 3982lm | 4000K  |

### MESA\_UGR<19\_DALI

- With DALI.



#### MODELS

| CODE       | MODEL                        | POWER | DIMENSION     | LUMEN  | KELVIN |
|------------|------------------------------|-------|---------------|--------|--------|
| 6003400078 | MESA100_42W_3K_UGR_3877_DALI | 42W   | 595x595x35 mm | 3877lm | 3000K  |
| 6003400079 | MESA100_42W_4K_UGR_3982_DALI | 42W   | 595x595x35 mm | 3982lm | 4000K  |

### MESA\_UGR<19\_EMERGENCY

- With emergency block. Working time 2h.



#### MODELS

| CODE       | MODEL                      | POWER | DIMENSION     | LUMEN  | EM. LUMEN  | EM. WORKING TIME | KELVIN |
|------------|----------------------------|-------|---------------|--------|------------|------------------|--------|
| 6003200078 | MESA100_42W_3K_UGR_3877_EM | 42W   | 595x595x35 mm | 3877lm | max 457 lm | 2h               | 3000K  |
| 6003200079 | MESA100_42W_4K_UGR_3982_EM | 42W   | 595x595x35 mm | 3982lm | max 457 lm | 2h               | 4000K  |

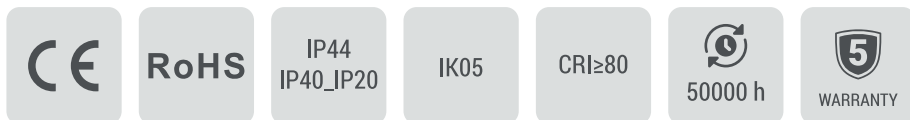
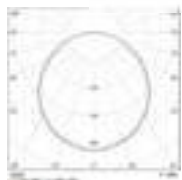

**SPECIFICATIONS**

- A recessed/surfaced/suspended with mounting cables LED luminaire with a 9/35 mm profile, 35 mm height.
- Electronic fixed output gear. IP44 from below, IP40\_IP20 from above, IK05.
- Body: sheet steel white (RAL9016). Diffuser: polycarbonate (PC), UV-stabilised.
- Complete with 3000K, 4000K.

**MODELS**

| CODE       | MODEL                   | POWER | DIMENSION     | LUMEN   | KELVIN |
|------------|-------------------------|-------|---------------|---------|--------|
| 6003000076 | MESA100_42W_3K_LED_4000 | 42W   | 595x595x35 mm | 3785 lm | 3000K  |
| 6003000077 | MESA100_42W_4K_LED_4200 | 42W   | 595x595x35 mm | 4176 lm | 4000K  |

## MESA\_0-10V\_DIMMABLE

- Dimmable: 0-10V.



### MODELS

| CODE       | MODEL                         | POWER | DIMENSION     | LUMEN   | KELVIN |
|------------|-------------------------------|-------|---------------|---------|--------|
| 6003100076 | MESA100_42W_3K_LED_3750_0-10V | 42W   | 595x595x35 mm | 3785 lm | 3000K  |
| 6003100077 | MESA100_42W_4K_LED_4200_0-10V | 42W   | 595x595x35 mm | 4176 lm | 4000K  |

## MESA\_TRIAC\_DIMMABLE

- Dimmable: TRIAC.



### MODELS

| CODE       | MODEL                         | POWER | DIMENSION     | LUMEN   | KELVIN |
|------------|-------------------------------|-------|---------------|---------|--------|
| 6003300076 | MESA100_42W_3K_LED_3750_TRIAC | 42W   | 595x595x35 mm | 3785 lm | 3000K  |
| 6003300077 | MESA100_42W_4K_LED_4200_TRIAC | 42W   | 595x595x35 mm | 4176 lm | 4000K  |

## MESA\_DALI

- With DALI.



### MODELS

| CODE       | MODEL                        | POWER | DIMENSION     | LUMEN   | KELVIN |
|------------|------------------------------|-------|---------------|---------|--------|
| 6003400076 | MESA100_42W_3K_LED_3750_DALI | 42W   | 595x595x35 mm | 3785 lm | 3000K  |
| 6003400077 | MESA100_42W_4K_LED_4200_DALI | 42W   | 595x595x35 mm | 4176 lm | 4000K  |

## MESA\_EMERGENCY

- With emergency block. Emergency working time 2h.



### MODELS

| CODE       | MODEL                      | POWER | DIMENSION     | LUMEN   | EM. LUMEN  | EM. WORKING TIME | KELVIN |
|------------|----------------------------|-------|---------------|---------|------------|------------------|--------|
| 6003200076 | MESA100_42W_3K_LED_3750_EM | 42W   | 595x595x35 mm | 3785 lm | max 457 lm | 2h               | 3000K  |
| 6003200077 | MESA100_42W_4K_LED_4200_EM | 42W   | 595x595x35 mm | 4176 lm | max 457 lm | 2h               | 4000K  |

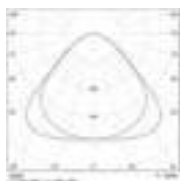

RoHS

IP44  
IP40\_IP20

IK05

CRI $\geq$ 70

4000K



50000 h



WARRANTY

## SPECIFICATIONS

- A recessed/surfaced/suspended with mounting cables LED luminaire with a 9/35 mm profile, 35 mm height.
- Electronic fixed output gear. IP44 from below, IP40\_IP20 from above, IK05.
- Body: sheet steel white (RAL9016). Diffuser: polycarbonate (PC), UV-stabilised.
- Complete with 4000K LED.

## MODELS

| CODE       | MODEL               | POWER | DIMENSION     | LUMEN   |
|------------|---------------------|-------|---------------|---------|
| 6003000029 | BRIG80_36W_LED_2880 | 36W   | 595x595x10 mm | 2991 lm |
| 6003000030 | BRIG80_42W_LED_3440 | 42W   | 595x595x10 mm | 3433 lm |

## BRIG\_EMERGENCY

- With emergency block. Emergency working time 2h.

IP44  
IP40\_IP20

IK05

CRI $\geq$ 70

4000K



50000 h



WARRANTY

## MODELS

| CODE       | MODEL                 | POWER | DIMENSION     | LUMEN   | EM. LUMEN  | EM. WORKING TIME |
|------------|-----------------------|-------|---------------|---------|------------|------------------|
| 6003200029 | BRIG80_36W_LED_2880EM | 36W   | 595x595x10 mm | 2991 lm | max 360 lm | 2 h              |
| 6003200030 | BRIG80_42W_LED_3440EM | 42W   | 595x595x10 mm | 3433 lm | max 360 lm | 2 h              |





**SPECIFICATIONS**

- A recessed/surfaced/suspended with mounting cables LED luminaire with a 9/35 mm profile, 35 mm height.
- Electronic fixed output gear. IP44 from below, IP40\_IP20 from above , IK05.
- Body: sheet steel white (RAL9016). Diffuser: polycarbonate (PC), UV-stabilised.
- Complete with 4000K.

RoHS
IP44 IP40\_IP20
IK05
CRI≥80
4000K
50000 h
WARRANTY

**MODELS**

| CODE       | MODEL                  | POWER | DIMENSION      | LUMEN   |
|------------|------------------------|-------|----------------|---------|
| 6003000016 | BURGAS100_42W_LED_4540 | 42W   | 1195x295x30 mm | 4245 lm |

**BURGAS\_0-10V\_DIMMABLE**

- Dimmable: 0-10V.

DIM
IP44\_IP20
IK05
CRI≥80
4000K
50000 h
WARRANTY

**MODELS**

| CODE       | MODEL                     | POWER | DIMENSION      | LUMEN   |
|------------|---------------------------|-------|----------------|---------|
| 6003100016 | BURGAS100_42W_LED_4540DIM | 42W   | 1195x295x30 mm | 4245 lm |

**BURGAS\_EMERGENCY**

- With emergency block. Emergency working time 2h.

EMERGENCY
IP44 IP40\_IP20
IK05
CRI≥80
4000K
50000 h
WARRANTY

**MODELS**

| CODE       | MODEL                    | POWER | DIMENSION      | LUMEN   | EM. LUMEN  | EM. WORKING TIME |
|------------|--------------------------|-------|----------------|---------|------------|------------------|
| 6003200016 | BURGAS100_42W_LED_4540EM | 42W   | 1195x295x30 mm | 4245 lm | max 397 lm | 2 h              |

## ACCESSORIES



| CODE       | MODEL      | NAME                              | DIMENSION  |
|------------|------------|-----------------------------------|------------|
| 6003300001 | SF_M_K_600 | TOPE Surface mounting kit 600x600 | 600x600 mm |



| CODE       | MODEL              | NAME                               | DIMENSION   |
|------------|--------------------|------------------------------------|-------------|
| 6003300002 | BURGAS_SF_M_K_1200 | TOPE Surface mounting kit 1200x300 | 1200x300 mm |



| CODE       | MODEL    | NAME                                  |
|------------|----------|---------------------------------------|
| 6003300003 | PE_SET_4 | TOPE Recessed mounting springs 4 pcs. |



| CODE       | MODEL    | NAME                             |
|------------|----------|----------------------------------|
| 6003300004 | SP_SET_4 | TOPE Pendant mounting set 4 pcs. |



LED  
SPOTLIGHTS

TOPE   
LIGHTING

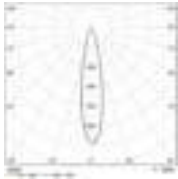

|      |      |      |        |       |            |     |
|------|------|------|--------|-------|------------|-----|
| RoHS | IP20 | IK05 | CRI≥80 | 4000K | 3 WARRANTY | 24° |
|------|------|------|--------|-------|------------|-----|

**SPECIFICATIONS**

- LED spotlight with flood distribution.
- Surfaced, 360° rotatable. 90° tilt adjustable.
- IP20. Body: Aluminum, powder coated.
- Complete with 4000K LED

**MODELS**

| CODE       | MODEL                  | POWER | DIMENSION   | LUMEN   | HOUSING COLOR |
|------------|------------------------|-------|-------------|---------|---------------|
| 6005000028 | OSLO100_W_10W_LED_1000 | 10 W  | Ø100x105 mm | 1001 lm | White         |
| 6005000029 | OSLO100_W_15W_LED_1000 | 15 W  | Ø100x105 mm | 1479 lm | White         |
| 6005000030 | OSLO100_B_10W_LED_1000 | 10 W  | Ø100x105 mm | 1001 lm | Black         |
| 6005000031 | OSLO100_B_15W_LED_1000 | 15 W  | Ø100x105mm  | 1479 lm | Black         |

**FINISH**

- BLACK
- WHITE



RoHS

  
IP20

IK05

CRI≥80

 $\frac{3000K}{4000K}$ 

  
WARRANTY

  
30°

## SPECIFICATIONS

- LED spotlight with flood distribution and integral fixed output control gear .
- Surface mounted.
- IP20. Body: die-cast aluminium, painted white or black.
- Complete with 3000K and 4000K LED.

## MODELS

| CODE       | MODEL                   | POWER | DIMENSION      | LUMEN | HOUSING COLOR | KELVIN |
|------------|-------------------------|-------|----------------|-------|---------------|--------|
| 6006000017 | TELA80_7W_W_3K_LED_560  | 7W    | 50x79x106x84mm | 560lm | White         | 3000K  |
| 6006000018 | TELA80_10W_W_3K_LED_800 | 10W   | 50x79x106x84mm | 800lm | White         | 3000K  |
| 6006000019 | TELA80_7W_W_4K_LED_560  | 7W    | 50x79x106x84mm | 560lm | White         | 4000K  |
| 6006000020 | TELA80_10W_W_4K_LED_800 | 10W   | 50x79x106x84mm | 800lm | White         | 4000K  |
| 6006000021 | TELA80_7W_B_3K_LED_560  | 7W    | 50x79x106x84mm | 560lm | Black         | 3000K  |
| 6006000022 | TELA80_10W_B_3K_LED_800 | 10W   | 50x79x106x84mm | 800lm | Black         | 3000K  |
| 6006000023 | TELA80_7W_B_4K_LED_560  | 7W    | 50x79x106x84mm | 560lm | Black         | 4000K  |
| 6006000024 | TELA80_10W_B_4K_LED_800 | 10W   | 50x79x106x84mm | 800lm | Black         | 4000K  |

## FINISH

● BLACK ○ WHITE



RoHS

IP20

IK05

CRI≥80

3000K

3  
WARRANTY

45°

## SPECIFICATIONS

- LED spotlight with flood distribution and integral fixed output control gear. .
- Surface mounted.
- IP20. Body: die-cast aluminium, painted white or black.
- Complete with 3000K LED.

## MODELS

| CODE       | MODEL                     | POWER | DIMENSION  | LUMEN  | HOUSING COLOR |
|------------|---------------------------|-------|------------|--------|---------------|
| 6006000025 | TULSA90_10W_W_3K_LED_900  | 10W   | Ø55x100mm  | 900lm  | White         |
| 6006000026 | TULSA90_15W_W_3K_LED_1350 | 15W   | Ø95x140mm  | 1350lm | White         |
| 6006000027 | TULSA90_20W_W_3K_LED_1800 | 20W   | Ø115x160mm | 1800lm | White         |
| 6006000028 | TULSA90_10W_B_3K_LED_900  | 10W   | Ø55x100mm  | 900lm  | Black         |
| 6006000029 | TULSA90_15W_B_3K_LED_1350 | 15W   | Ø95x140mm  | 1350lm | Black         |
| 6006000030 | TULSA90_20W_B_3K_LED_1800 | 20W   | Ø115x160mm | 1800lm | Black         |

## FINISH

● BLACK ○ WHITE



RoHS

  
IP20

IK05

CRI≥80

  
3000K

  
WARRANTY

  
45°

## SPECIFICATIONS

- LED spotlight with flood distribution and integral fixed output control . .
- Surface mounted.
- IP20. Body: die-cast aluminium, painted white or black.
- Complete with 3000K LED.

## MODELS

| CODE       | MODEL                     | POWER | DIMENSION   | LUMEN  | HOUSING COLOR |
|------------|---------------------------|-------|-------------|--------|---------------|
| 6006000031 | TANGA90_7W_W_3K_LED_630   | 7W    | 55x55x120mm | 630lm  | White         |
| 6006000032 | TANGA90_12W_W_3K_LED_1080 | 12W   | 75x75x140mm | 1080lm | White         |
| 6006000033 | TANGA90_15W_W_3K_LED_1350 | 15W   | 96x96x150mm | 1350lm | White         |
| 6006000034 | TANGA90_7W_B_3K_LED_630   | 7W    | 55x55x120mm | 630lm  | Black         |
| 6006000035 | TANGA90_12W_B_3K_LED_1080 | 12W   | 75x75x140mm | 1080lm | Black         |
| 6006000036 | TANGA90_15W_B_3K_LED_1350 | 15W   | 96x96x150mm | 1350lm | Black         |

## FINISH

BLACK
  WHITE



RoHS



IP20

IK05

CRI≥80



3000K



WARRANTY



36°

## SPECIFICATIONS

- LED spotlight with flood distribution and integral fixed output control gear .
- Surface mounted.
- IP20. Body: die-cast aluminium, painted white or black.
- Complete with 3000K LED.

## MODELS

| CODE       | MODEL                   | POWER | DIMENSION  | LUMEN | HOUSING COLOR |
|------------|-------------------------|-------|------------|-------|---------------|
| 6006000037 | TARTU80_10W_W_4_LED_900 | 10W   | Ø 60x395mm | 900lm | White         |
| 6006000038 | TARTU80_10W_W_5_LED_900 | 10W   | Ø 60x494mm | 900lm | White         |
| 6006000039 | TARTU80_10W_W_6_LED_900 | 10W   | Ø 60x597mm | 900lm | White         |
| 6006000040 | TARTU80_10W_W_7_LED_901 | 10W   | Ø 60x695mm | 901lm | White         |
| 6006000041 | TARTU80_10W_B_4_LED_900 | 10W   | Ø 60x395mm | 900lm | Black         |
| 6006000042 | TARTU80_10W_B_5_LED_900 | 10W   | Ø 60x494mm | 900lm | Black         |
| 6006000043 | TARTU80_10W_B_6_LED_900 | 10W   | Ø 60x597mm | 900lm | Black         |
| 6006000044 | TARTU80_10W_B_7_LED_901 | 10W   | Ø 60x695mm | 901lm | Black         |

## FINISH



BLACK



WHITE



A modern living room featuring a magnetic LED lighting system. The ceiling is equipped with a black track containing several recessed LED strips and spotlights. A large, white, rectangular fireplace unit is illuminated from within, casting a warm glow. The room includes a grey sofa with patterned and solid pillows, a black coffee table with glassware, and a kitchen area in the background. Large windows with light-colored curtains are visible on the left. The floor is made of light-colored wood.

# MAGNETIC LED SYSTEM

**TOPE** &  
**LIGHTING**

|             |   |      |   |                              |  |  |
|-------------|---|------|---|------------------------------|--|--|
| <b>RoHS</b> | <br>IP20 | IK05 | <br>REMOTE | <b>3000K</b><br><b>6000K</b> | <br>30000 h | <br>WARRANTY |
|-------------|---|------|---|------------------------------|--|--|

**SPECIFICATIONS**

- LED spotlight with flood distribution and integral fixed output control gear.
- Surface mounted.
- IP20. Body: die-cast aluminium, painted black.
- Complete with 3000K-6000K LED.

**MODELS**

| PHOTOS  | CODE       | MODEL                    | POWER | BEAM ANGLE | DIMENSION           |
|---|------------|--------------------------|-------|------------|---------------------|
|    | 6006000045 | TAMPA90_7W_TM_LED_630    | 7W    | 24°        | Ø50x100mm           |
|   | 6006000046 | TAMPA90_12W_TM_LED_1080  | 12W   | 24°        | Ø50x120mm           |
|   | 6006000047 | TAMPA90_20W_TM_LED_1800  | 20W   | 24°        | Ø55x140mm           |
|    | 6006000048 | TAMPA90_6W_GAM_LED_540   | 6W    | 24°        | 112x22x136mm        |
|   | 6006000049 | TAMPA90_12W_GAM_LED_1080 | 12W   | 24°        | 225x22x136mm        |
|    | 6006000050 | TAMPA90_12W_LM_LED_1080  | 12W   | 120°       | 300x22x25mm         |
|   | 6006000051 | TAMPA90_18W_LM_LED_1620  | 18W   | 120°       | 600x22x25mm         |
|   | 6006000052 | TAMPA90_36W_LM_LED_3240  | 36W   | 120°       | 1200x22x25mm        |
|   | 6006000053 | TAMPA90_6W_GM_LED_540    | 6W    | 24°        | 135x22x25mm         |
|   | 6006000054 | TAMPA90_12W_GM_LED_1080  | 12W   | 24°        | 270x22x25mm         |
|  | 6006000055 | TAMPA90_7W_PM_LED_630    | 7W    | 24°        | Ø40x300mm           |
|  | 6006000056 | TAMPA90_7W_BM_LED_630    | 7W    | 24°        | Ø100mm              |
|  | 6006000057 | TAMPA90_7W_PBM_LED_630   | 7W    | 24°        | Ø100<br>wire 100mm  |
|  | 6006000058 | TAMPA90_5W_CM_LED_633    | 5W    | 24°        | Ø84x75<br>wire100mm |

## TAMPA MAGNETIC LED SYSTEM



| PHOTOS | CODE       | NAME  |
|--------|------------|---|
|        | 6006100018 | TOPE LED MAGNETIC SYSTEM TAMPA, SURFACE RAIL, 53x26x2000mm  |
|        | 6006100020 | TOPE LED MAGNETIC SYSTEM TAMPA, RECESSED RAIL, 56x44x2000mm, Embedded plastering                    |
|        | 6006100021 | TOPE LED MAGNETIC SYSTEM TAMPA, PENDANT WIRE SET, 2 PCS   |
|        | 6006100022 | TOPE LED MAGNETIC SYSTEM TAMPA, INPUT CONDUCTIVE MODULE (for external driver connection) 0,5m wire. |
|        | 6006100023 | TOPE LED MAGNETIC SYSTEM TAMPA, CORNER CONDUCTIVE MODULE  |
|        | 6006100024 | TOPE LED MAGNETIC SYSTEM TAMPA, THROUGH CONDUCTIVE MODULE   |
|        | 6006100025 | TOPE LED MAGNETIC SYSTEM TAMPA, SURFACE CONNECTION PLATE  |
|        | 6006100026 | TOPE LED MAGNETIC SYSTEM TAMPA, SURFACE CORNER  |
|        | 6006100027 | TOPE LED MAGNETIC SYSTEM TAMPA, SURFACE CLOSED CORNER   |
|        | 6006100028 | TOPE LED MAGNETIC SYSTEM TAMPA, RECESSED CORNER   |
|        | 6006100029 | TOPE LED MAGNETIC SYSTEM TAMPA, RECESSED CLOSED CORNER  |
|        | 6006100030 | TOPE LED MAGNETIC SYSTEM TAMPA, INTERNAL POWER SUPPLY. 48V, 50/60Hz, 100W max.                      |
|        | 6006100032 | TOPE LED MAGNETIC SYSTEM TAMPA, RF 2,4G REMOTE FOR CCT ADJUSTING AND DIMMING                        |
|        | 6006100033 | TOPE LED MAGNETIC SYSTEM TAMPA, INTERNAL POWER SUPPLY. 48V, 50/60Hz, 200W max.                      |

|             |   |             |   |                        |  |  |
|-------------|---|-------------|---|------------------------|--|--|
| <b>RoHS</b> |  <b>IP20</b> | <b>IK05</b> |  <b>REMOTE</b> | <b>3000K<br/>6000K</b> |  <b>30000 h</b> |  <b>2<br/>WARRANTY</b> |
|-------------|---|-------------|---|------------------------|--|--|

**SPECIFICATIONS**

- LED spotlight with flood distribution and integral fixed output control gear.
- Surface mounted.
- IP20. Body: die-cast aluminium, painted black.
- Complete with 3000K-6000K LED.

**MODELS**

| PHOTOS  | CODE       | MODEL                       | POWER | BEAM ANGLE | DIMENSION           |
|---|------------|-----------------------------|-------|------------|---------------------|
|    | 6006000059 | TAMPA90_7W_TM_LED_630_WH    | 7W    | 24°        | Ø50x100mm           |
|   | 6006000060 | TAMPA90_12W_TM_LED_1080_WH  | 12W   | 24°        | Ø50x120mm           |
|   | 6006000061 | TAMPA90_20W_TM_LED_1800_WH  | 20W   | 24°        | Ø55x140mm           |
|    | 6006000062 | TAMPA90_6W_GAM_LED_540_WH   | 6W    | 24°        | 112x22x136mm        |
|   | 6006000063 | TAMPA90_12W_GAM_LED_1080_WH | 12W   | 24°        | 225x22x136mm        |
|   | 6006000064 | TAMPA90_12W_LM_LED_1080_WH  | 12W   | 120°       | 300x22x25mm         |
|   | 6006000065 | TAMPA90_18W_LM_LED_1620_WH  | 18W   | 120°       | 600x22x25mm         |
|   | 6006000066 | TAMPA90_36W_LM_LED_3240_WH  | 36W   | 120°       | 1200x22x25mm        |
|  | 6006000067 | TAMPA90_6W_GM_LED_540_WH    | 6W    | 24°        | 135x22x25mm         |
|   | 6006000068 | TAMPA90_12W_GM_LED_1080_WH  | 12W   | 24°        | 270x22x25mm         |
|  | 6006000069 | TAMPA90_7W_PM_LED_630_WH    | 7W    | 24°        | Ø40x300mm           |
|  | 6006000072 | TAMPA90_5W_PM_LED_633_WH    | 5W    | 24°        | Ø84x75<br>wire100mm |

## TAMPA MAGNETIC LED SYSTEM

| PHOTOS | CODE       | NAME  |
|--------|------------|---|
|        | 6006100034 | TOPE LED MAGNETIC SYSTEM TAMPA, SURFACE RAIL, 53x26x2000mm  |
|        | 6006100035 | TOPE LED MAGNETIC SYSTEM TAMPA, RECESSED RAIL, 56x44x2000mm, Embedded plastering                    |
|        | 6006100036 | TOPE LED MAGNETIC SYSTEM TAMPA, PENDANT WIRE SET, 2 PCS   |
|        | 6006100037 | TOPE LED MAGNETIC SYSTEM TAMPA, INPUT CONDUCTIVE MODULE (for external driver connection) 0,5m wire. |
|        | 6006100038 | TOPE LED MAGNETIC SYSTEM TAMPA, CORNER CONDUCTIVE MODULE  |
|        | 6006100039 | TOPE LED MAGNETIC SYSTEM TAMPA, THROUGH CONDUCTIVE MODULE   |
|        | 6006100040 | TOPE LED MAGNETIC SYSTEM TAMPA, SURFACE CONNECTION PLATE  |
|        | 6006100041 | TOPE LED MAGNETIC SYSTEM TAMPA, SURFACE CORNER  |
|        | 6006100042 | TOPE LED MAGNETIC SYSTEM TAMPA, SURFACE CLOSED CORNER   |
|        | 6006100043 | TOPE LED MAGNETIC SYSTEM TAMPA, RECESSED CORNER   |
|        | 6006100044 | TOPE LED MAGNETIC SYSTEM TAMPA, RECESSED CLOSED CORNER  |
|        | 6006100045 | TOPE LED MAGNETIC SYSTEM TAMPA, INTERNAL POWER SUPPLY. 48V, 50/60Hz, 100W max.                      |
|        | 6006100046 | TOPE LED MAGNETIC SYSTEM TAMPA, INTERNAL POWER SUPPLY. 48V, 50/60Hz, 200W max.                      |
|        | 6006100032 | TOPE LED MAGNETIC SYSTEM TAMPA, RF 2,4G REMOTE FOR CCT ADJUSTING AND DIMMING                        |

LED TRACK  
SYSTEM 3/4 WIRE





SPECIFICATIONS

- LED spotlight with flood distribution and integral fixed output control gear.
- Track mounted, two wire.
- IP20. Body: die-cast aluminium, painted white or black. Driver box: white or black.
- Complete with 3000K and 4000K LED.

3 WIRE IP20 IK05 CRI>80 3000K 4000K 3 WARRANTY RoHS

MODELS

| CODE       | MODEL                    | POWER | BEAM ANGLE | DIMENSION            | LUMEN  | HOUSING COLOR | KELVIN |
|------------|--------------------------|-------|------------|----------------------|--------|---------------|--------|
| 6006000001 | TALA80_7W_W_3K_LED_560   | 7W    | 30°        | Ø 48x78x36x40x83mm   | 560lm  | White         | 3000K  |
| 6006000002 | TALA80_12W_W_3K_LED_960  | 12W   | 40°        | Ø 48x108x36x45x122mm | 960lm  | White         | 3000K  |
| 6006000003 | TALA80_20W_W_3K_LED_1600 | 20W   | 30°        | Ø 57x133x48x45x122mm | 1600lm | White         | 3000K  |
| 6006000004 | TALA80_7W_W_4K_LED_560   | 7W    | 30°        | Ø 48x78x36x40x83mm   | 560lm  | White         | 4000K  |
| 6006000005 | TALA80_12W_W_4K_LED_960  | 12W   | 40°        | Ø 48x108x36x45x122mm | 960lm  | White         | 4000K  |
| 6006000006 | TALA80_20W_W_4K_LED_1600 | 20W   | 30°        | Ø 57x133x48x45x122mm | 1600lm | White         | 4000K  |
| 6006000007 | TALA80_30W_W_4K_LED_2400 | 30W   | 30°        | Ø 71x138x60x50x166mm | 2400lm | White         | 4000K  |
| 6006000009 | TALA80_7W_B_3K_LED_560   | 7W    | 30°        | Ø 48x78x36x40x83mm   | 560lm  | Black         | 3000K  |
| 6006000010 | TALA80_12W_B_3K_LED_960  | 12W   | 40°        | Ø 48x108x36x45x122mm | 960lm  | Black         | 3000K  |
| 6006000011 | TALA80_20W_B_3K_LED_1600 | 20W   | 30°        | Ø 57x133x48x45x122mm | 1600lm | Black         | 3000K  |
| 6006000012 | TALA80_7W_B_4K_LED_560   | 7W    | 30°        | Ø 48x78x36x40x83mm   | 560lm  | Black         | 4000K  |
| 6006000013 | TALA80_12W_B_4K_LED_960  | 12W   | 40°        | Ø 48x108x36x45x122mm | 960lm  | Black         | 4000K  |
| 6006000014 | TALA80_20W_B_4K_LED_1600 | 20W   | 30°        | Ø 57x133x48x45x122mm | 1600lm | Black         | 4000K  |
| 6006000015 | TALA80_30W_B_4K_LED_2400 | 30W   | 30°        | Ø 71x138x60x50x166mm | 2400lm | Black         | 4000K  |



MODEL 5

4 WIRE IP20 IK05 CRI>80 3000K 4000K 3 WARRANTY RoHS

| CODE       | MODEL                    | POWER | BEAM ANGLE | DIMENSION            | LUMEN  | HOUSING COLOR | KELVIN |
|------------|--------------------------|-------|------------|----------------------|--------|---------------|--------|
| 6006000008 | TALA80_40W_W_4K_LED_3400 | 40W   | 40°        | Ø 90x150x50x67x205mm | 3400lm | White         | 4000K  |
| 6006000016 | TALA80_40W_B_4K_LED_3400 | 40W   | 40°        | Ø 90x150x50x67x205mm | 3400lm | Black         | 4000K  |

FINISH



## TALA LED TRACK SYSTEM, 3WIRE

| PHOTOS | CODE       | NAME  |
|--------|------------|---|
|        | 6006100001 | TOPE LED TRACK SYSTEM TALA, SURFACE RAIL. 3 wire, white, 18x35x1000 mm. 0.95mm thick  |
|        | 6006100002 | TOPE LED TRACK SYSTEM TALA, SURFACE RAIL. 3 wire, white, 18x35x2000 mm. 0.95 mm thick |
|        | 6006100003 | TOPE LED TRACK SYSTEM TALA, 3 WIRE, LIVE END CONNECTOR, white.                        |
|        | 6006100004 | TOPE LED TRACK SYSTEM TALA, 3 WIRE, STRAIGHT CONNECTOR, white.                        |
|        | 6006100005 | TOPE LED TRACK SYSTEM TALA, 3 WIRE, L SHAPE CONNECTOR, white.                         |
|        | 6006100006 | TOPE LED TRACK SYSTEM TALA, 3 WIRE, T SHAPE CONNECTOR, white.                         |
|        | 6006100007 | TOPE LED TRACK SYSTEM TALA, 3 WIRE, X SHAPE CONNECTOR, white.                         |
|        | 6006100008 | TOPE LED TRACK SYSTEM TALA, 3 WIRE, END CAP, white.                                   |
|        | 6006100009 | TOPE LED TRACK SYSTEM TALA, SURFACE RAIL. 3 WIRE, black, 18x35x1000 mm. 0.95mm thick  |
|        | 6006100010 | TOPE LED TRACK SYSTEM TALA, SURFACE RAIL. 3 WIRE, black, 18x35x2000 mm. 0,95mm thick  |
|        | 6006100011 | TOPE LED TRACK SYSTEM TALA, 3 WIRE, LIVE END CONNECTOR, black.                        |
|        | 6006100012 | TOPE LED TRACK SYSTEM TALA, 3 WIRE, STRAIGHT CONNECTOR, black.                        |
|        | 6006100013 | TOPE LED TRACK SYSTEM TALA, 3 WIRE, L SHAPE CONNECTOR, black.                         |
|        | 6006100014 | TOPE LED TRACK SYSTEM TALA, 3 WIRE, T SHAPE CONNECTOR, black.                         |
|        | 6006100015 | TOPE LED TRACK SYSTEM TALA, 3 WIRE, X SHAPE CONNECTOR, black.                         |
|        | 6006100016 | TOPE LED TRACK SYSTEM TALA, 3 WIRE, END CAP, black.                                   |





LED LINEAR  
LIGHT

TOPE <sup>sp</sup>  
LIGHTING

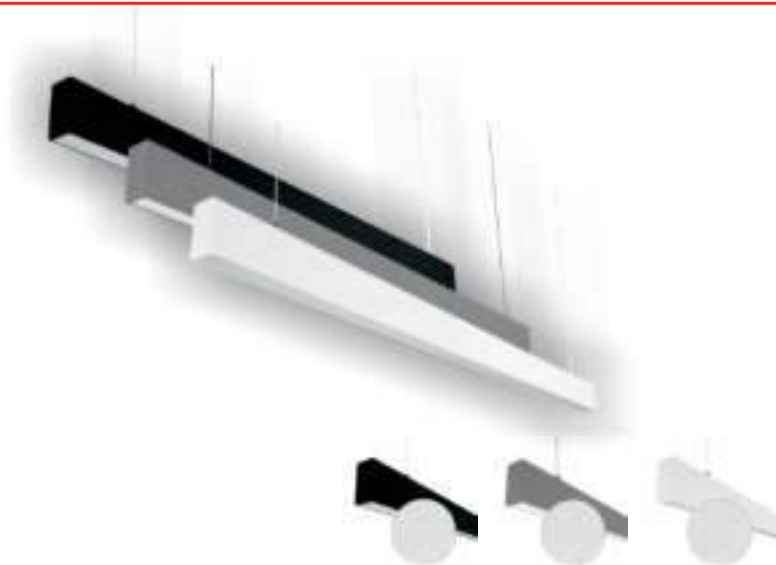

## SPECIFICATIONS

- Oblong, linear LED luminaire, hung on cables (max 1m long cables) or attached to the ceiling.
- Constant power electronic power supply.
- Housing: extruded anodized aluminum. End caps: extruded aluminum.
- The luminaire is painted with powder paint. Lens: acrylic.
- Optimal light comfort – UGR < 19.
- Can be produce with 3000K, 4500K or 6000K LED.

## MODELS

| CODE       | MODEL                      | POWER | DIMENSION     | LUMEN   | HOUSING COLOR |
|------------|----------------------------|-------|---------------|---------|---------------|
| 6004000096 | LOTA100_20W_G_LED_UGR_2000 | 20W   | 585x67x35 mm  | 1700 lm | Grey          |
| 6004000097 | LOTA100_40W_G_LED_UGR_4000 | 40 W  | 1163x67x35 mm | 4000 lm | Grey          |
| 6004000098 | LOTA100_60W_G_LED_UGR_6000 | 60 W  | 1745x67x35 mm | 5700 lm | Grey          |
| 6004000099 | LOTA100_80W_G_LED_UGR_8000 | 80 W  | 2325x67x35 mm | 8000 lm | Grey          |
| 6004000100 | LOTA100_20W_B_LED_UGR_2000 | 20W   | 585x67x35 mm  | 1700 lm | Black         |
| 6004000101 | LOTA100_40W_B_LED_UGR_4000 | 40 W  | 1163x67x35 mm | 4000 lm | Black         |
| 6004000102 | LOTA100_60W_B_LED_UGR_6000 | 60 W  | 1745x67x35 mm | 5700 lm | Black         |
| 6004000103 | LOTA100_80W_B_LED_UGR_8000 | 80 W  | 2325x67x35 mm | 8000 lm | Black         |
| 6004000104 | LOTA100_20W_W_LED_UGR_2000 | 20W   | 585x67x35 mm  | 1700 lm | White         |
| 6004000105 | LOTA100_40W_W_LED_UGR_4000 | 40 W  | 1163x67x35 mm | 4000 lm | White         |
| 6004000106 | LOTA100_60W_W_LED_UGR_6000 | 60 W  | 1745x67x35 mm | 5700 lm | White         |
| 6004000107 | LOTA100_80W_W_LED_UGR_8000 | 80 W  | 2325x67x35 mm | 8000 lm | White         |

## LOTA100\_UGR<19\_0-10V\_DIMMABLE

- Dimmable: 0-10V



### MODELS

| CODE       | MODEL                       | POWER | DIMENSION     | LUMEN   | HOUSING COLOR |
|------------|-----------------------------|-------|---------------|---------|---------------|
| 6004100097 | LOTA100_40W_G_LED_UGR_0-10V | 40 W  | 1163x67x35 mm | 4000 lm | Grey          |
| 6004100099 | LOTA100_80W_G_LED_UGR_0-10V | 80 W  | 2325x67x35 mm | 8000 lm | Grey          |
| 6004100101 | LOTA100_40W_B_LED_UGR_0-10V | 40 W  | 1163x67x35 mm | 4000 lm | Black         |
| 6004100103 | LOTA100_80W_B_LED_UGR_0-10V | 80 W  | 2325x67x35 mm | 8000 lm | Black         |
| 6004100105 | LOTA100_40W_W_LED_UGR_0-10V | 40 W  | 1163x67x35 mm | 4000 lm | White         |
| 6004100107 | LOTA100_80W_W_LED_UGR_0-10V | 80 W  | 2325x67x35 mm | 8000 lm | White         |

## LOTA100\_UGR<19\_DALI

- With DALI



### MODELS

| CODE       | MODEL                      | POWER | DIMENSION     | LUMEN   | HOUSING COLOR |
|------------|----------------------------|-------|---------------|---------|---------------|
| 6004400097 | LOTA100_40W_G_LED_UGR_DALI | 40 W  | 1163x67x35 mm | 4000 lm | Grey          |
| 6004400099 | LOTA100_80W_G_LED_UGR_DALI | 80 W  | 2325x67x35 mm | 8000 lm | Grey          |
| 6004400101 | LOTA100_40W_B_LED_UGR_DALI | 40 W  | 1163x67x35 mm | 4000 lm | Black         |
| 6004400103 | LOTA100_80W_B_LED_UGR_DALI | 80 W  | 2325x67x35 mm | 8000 lm | Black         |
| 6004400105 | LOTA100_40W_W_LED_UGR_DALI | 40 W  | 1163x67x35 mm | 4000 lm | White         |
| 6004400107 | LOTA100_80W_W_LED_UGR_DALI | 80 W  | 2325x67x35 mm | 8000 lm | White         |

## LOTA100\_UGR<19\_SENS

- Completed with motion sensor.

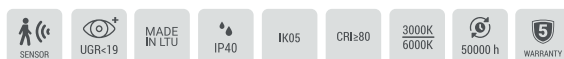

### MODELS

| CODE       | MODEL                      | POWER | DIMENSION     | LUMEN   | HOUSING COLOR |
|------------|----------------------------|-------|---------------|---------|---------------|
| 6004700096 | LOTA100_20W_G_LED_UGR_SENS | 20W   | 585x67x35 mm  | 1700 lm | Grey          |
| 6004700097 | LOTA100_40W_G_LED_UGR_SENS | 40 W  | 1163x67x35 mm | 4000 lm | Grey          |
| 6004700098 | LOTA100_60W_G_LED_UGR_SENS | 60 W  | 1745x67x35 mm | 5700 lm | Grey          |
| 6004700099 | LOTA100_80W_G_LED_UGR_SENS | 80 W  | 2325x67x35 mm | 8000 lm | Grey          |
| 6004700100 | LOTA100_20W_B_LED_UGR_SENS | 20W   | 585x67x35 mm  | 1700 lm | Black         |
| 6004700101 | LOTA100_40W_B_LED_UGR_SENS | 40 W  | 1163x67x35 mm | 4000 lm | Black         |
| 6004700102 | LOTA100_60W_B_LED_UGR_SENS | 60 W  | 1745x67x35 mm | 5700 lm | Black         |
| 6004700103 | LOTA100_80W_B_LED_UGR_SENS | 80 W  | 2325x67x35 mm | 8000 lm | Black         |
| 6004700104 | LOTA100_20W_W_LED_UGR_SENS | 20W   | 585x67x35 mm  | 1700 lm | White         |
| 6004700105 | LOTA100_40W_W_LED_UGR_SENS | 40 W  | 1163x67x35 mm | 4000 lm | White         |
| 6004700106 | LOTA100_60W_W_LED_UGR_SENS | 60 W  | 1745x67x35 mm | 5700 lm | White         |
| 6004700107 | LOTA100_80W_W_LED_UGR_SENS | 80 W  | 2325x67x35 mm | 8000 lm | White         |



MADE  
IN LTU

IP40

IK05

CRI≥80

4000K

30000 h

3  
WARRANTY

## SPECIFICATIONS

- Oblong, linear LED luminaire, hung on cables (max 1m long cables) or attached to the ceiling.
- Constant power electronic power supply.
- Housing: extruded anodized aluminum. End caps: extruded aluminum.
- The luminaire is painted with powder paint. Lens: acrylic.
- Optimal light comfort – UGR < 19.
- Can be produce with 4000K LED.

## MODELS

| CODE       | MODEL                   | POWER | DIMENSION     | LUMEN   | HOUSING COLOR |
|------------|-------------------------|-------|---------------|---------|---------------|
| 6004000108 | LOTA_20W_G_LED_UGR_1800 | 20W   | 550x67x35 mm  | 1678 lm | Grey          |
| 6004000109 | LOTA_40W_G_LED_UGR_3600 | 40 W  | 1163x67x35 mm | 3011lm  | Grey          |
| 6004000110 | LOTA_54W_G_LED_UGR_5000 | 54 W  | 1705x67x35 mm | 4689 lm | Grey          |
| 6004000111 | LOTA_72W_G_LED_UGR_6800 | 72 W  | 2315x67x35 mm | 6022 lm | Grey          |
| 6004000112 | LOTA_20W_B_LED_UGR_1800 | 20W   | 550x67x35 mm  | 1678 lm | Black         |
| 6004000113 | LOTA_40W_B_LED_UGR_3600 | 40 W  | 1163x67x35 mm | 3011 lm | Black         |
| 6004000114 | LOTA_54W_B_LED_UGR_5000 | 54 W  | 1705x67x35 mm | 4689 lm | Black         |
| 6004000115 | LOTA_72W_B_LED_UGR_6800 | 72 W  | 2315x67x35 mm | 6022 lm | Black         |
| 6004000116 | LOTA_20W_W_LED_UGR_1800 | 20W   | 550x67x35 mm  | 1678 lm | White         |
| 6004000117 | LOTA_40W_W_LED_UGR_3600 | 40 W  | 1163x67x35 mm | 3011 lm | White         |
| 6004000118 | LOTA_54W_W_LED_UGR_5000 | 54 W  | 1705x67x35 mm | 4689 lm | White         |
| 6004000119 | LOTA_72W_W_LED_UGR_6800 | 72 W  | 2315x67x35 mm | 6022 lm | White         |



MADE  
IN LTU

  
IP40

IK05

CRI≥80

$\frac{3000K}{6000K}$

  
50000 h

  
5  
WARRANTY

## SPECIFICATIONS

- Oblong, linear LED luminaire, hung on cables (max 1m long cables) or attached to the ceiling.
- Constant power electronic power supply.
- Housing: extruded anodized aluminum. End caps: extruded aluminum.
- The luminaire is painted with powder paint. Lens: acrylic.
- Can be produce with 3000K, 4500K or 6000K LED.

## MODELS

| CODE       | MODEL                  | POWER | DIMENSION     | LUMEN   | HOUSING COLOR |
|------------|------------------------|-------|---------------|---------|---------------|
| 6004000120 | LOTA100_20W_G_LED_2000 | 20 W  | 585x67x35 mm  | 1700 lm | Grey          |
| 6004000121 | LOTA100_40W_G_LED_4000 | 40 W  | 1163x67x35 mm | 4000 lm | Grey          |
| 6004000122 | LOTA100_60W_G_LED_6000 | 60 W  | 1745x67x35 mm | 5700 lm | Grey          |
| 6004000123 | LOTA100_80W_G_LED_8000 | 80 W  | 2325x67x35 mm | 8000 lm | Grey          |
| 6004000124 | LOTA100_20W_B_LED_2000 | 20 W  | 585x67x35 mm  | 1700 lm | Black         |
| 6004000125 | LOTA100_40W_B_LED_4000 | 40 W  | 1163x67x35 mm | 4000 lm | Black         |
| 6004000126 | LOTA100_60W_B_LED_6000 | 60 W  | 1745x67x35 mm | 5700 lm | Black         |
| 6004000127 | LOTA100_80W_B_LED_8000 | 80 W  | 2325x67x35 mm | 8000 lm | Black         |
| 6004000128 | LOTA100_20W_W_LED_2000 | 20 W  | 585x67x35 mm  | 1700 lm | White         |
| 6004000129 | LOTA100_40W_W_LED_4000 | 40 W  | 1163x67x35 mm | 4000 lm | White         |
| 6004000130 | LOTA100_60W_W_LED_6000 | 60 W  | 1745x67x35 mm | 5700 lm | White         |
| 6004000131 | LOTA100_80W_W_LED_8000 | 80 W  | 2325x67x35 mm | 8000 lm | White         |

## LOTA100\_0-10V\_DIMMABLE

- Dimmable: 0-10V



### MODELS

| CODE       | MODEL                   | POWER | DIMENSION     | LUMEN   | HOUSING COLOR |
|------------|-------------------------|-------|---------------|---------|---------------|
| 6004100121 | LOTA100_40W_G_LED_0-10V | 40 W  | 1163x67x35 mm | 4000 lm | Grey          |
| 6004100123 | LOTA100_80W_G_LED_0-10V | 80 W  | 2325x67x35 mm | 8000 lm | Grey          |
| 6004100125 | LOTA100_40W_B_LED_0-10V | 40 W  | 1163x67x35 mm | 4000 lm | Black         |
| 6004100127 | LOTA100_80W_B_LED_0-10V | 80 W  | 2325x67x35 mm | 8000 lm | Black         |
| 6004100129 | LOTA100_40W_W_LED_0-10V | 40 W  | 1163x67x35 mm | 4000 lm | White         |
| 6004100131 | LOTA100_80W_W_LED_0-10V | 80 W  | 2325x67x35 mm | 8000 lm | White         |

## LOTA100\_DALI

- With DALI



### MODELS

| CODE       | MODEL                  | POWER | DIMENSION     | LUMEN   | HOUSING COLOR |
|------------|------------------------|-------|---------------|---------|---------------|
| 6004400121 | LOTA100_40W_G_LED_DALI | 40 W  | 1163x67x35 mm | 4000 lm | Grey          |
| 6004400123 | LOTA100_80W_G_LED_DALI | 80 W  | 2325x67x35 mm | 8000 lm | Grey          |
| 6004400125 | LOTA100_40W_B_LED_DALI | 40 W  | 1163x67x35 mm | 4000 lm | Black         |
| 6004400127 | LOTA100_80W_B_LED_DALI | 80 W  | 2325x67x35 mm | 8000 lm | Black         |
| 6004400129 | LOTA100_40W_W_LED_DALI | 40 W  | 1163x67x35 mm | 4000 lm | White         |
| 6004400131 | LOTA100_80W_W_LED_DALI | 80 W  | 2325x67x35 mm | 8000 lm | White         |

## LOTA100\_SENS

- Completed with motion sensor.



### MODELS

| CODE       | MODEL                  | POWER | DIMENSION     | LUMEN   | HOUSING COLOR |
|------------|------------------------|-------|---------------|---------|---------------|
| 6004700120 | LOTA100_20W_G_LED_SENS | 20W   | 585x67x35 mm  | 1700 lm | Grey          |
| 6004700121 | LOTA100_40W_G_LED_SENS | 40 W  | 1163x67x35 mm | 4000 lm | Grey          |
| 6004700122 | LOTA100_60W_G_LED_SENS | 60 W  | 1745x67x35 mm | 5700 lm | Grey          |
| 6004700123 | LOTA100_80W_G_LED_SENS | 80 W  | 2325x67x35 mm | 8000 lm | Grey          |
| 6004700124 | LOTA100_20W_B_LED_SENS | 20W   | 585x67x35 mm  | 1700 lm | Black         |
| 6004700125 | LOTA100_40W_B_LED_SENS | 40 W  | 1163x67x35 mm | 4000 lm | Black         |
| 6004700126 | LOTA100_60W_B_LED_SENS | 60 W  | 1745x67x35 mm | 5700 lm | Black         |
| 6004700127 | LOTA100_80W_B_LED_SENS | 80 W  | 2325x67x35 mm | 8000 lm | Black         |
| 6004700128 | LOTA100_20W_W_LED_SENS | 20W   | 585x67x35 mm  | 1700 lm | White         |
| 6004700129 | LOTA100_40W_W_LED_SENS | 40 W  | 1163x67x35 mm | 4000 lm | White         |
| 6004700130 | LOTA100_60W_W_LED_SENS | 60 W  | 1745x67x35 mm | 5700 lm | White         |
| 6004700131 | LOTA100_80W_W_LED_SENS | 80 W  | 2325x67x35 mm | 8000 lm | White         |



MADE  
IN LTU

  
**IP40**

IK05

CRI≥80

4000K

  
**30000 h**

  
**WARRANTY**

### SPECIFICATIONS

- Oblong, linear LED luminaire, hung on cables (max 1m long cables) or attached to the ceiling.
- Constant power electronic power supply.
- Housing: extruded anodized aluminum. End caps: extruded aluminum.
- The luminaire is painted with powder paint. Lens: acrylic.
- Can be produce with 4000K LED.

### MODELS

| CODE       | MODEL               | POWER | DIMENSION     | LUMEN  | HOUSING COLOR |
|------------|---------------------|-------|---------------|--------|---------------|
| 6004000132 | LOTA_20W_G_LED_1800 | 20W   | 550x67x35 mm  | 1678lm | Grey          |
| 6004000133 | LOTA_40W_G_LED_3600 | 40 W  | 1163x67x35 mm | 3011lm | Grey          |
| 6004000134 | LOTA_54W_G_LED_5000 | 54W   | 1705x67x35 mm | 4689lm | Grey          |
| 6004000135 | LOTA_72W_G_LED_6800 | 72W   | 2315x67x35 mm | 6022lm | Grey          |
| 6004000136 | LOTA_20W_B_LED_1800 | 20W   | 550x67x35 mm  | 1678lm | Black         |
| 6004000137 | LOTA_40W_B_LED_3600 | 40 W  | 1163x67x35 mm | 3011lm | Black         |
| 6004000138 | LOTA_54W_B_LED_5000 | 54W   | 1705x67x35 mm | 4689lm | Black         |
| 6004000139 | LOTA_72W_B_LED_6800 | 72W   | 2315x67x35 mm | 6022lm | Black         |
| 6004000140 | LOTA_20W_W_LED_1800 | 20W   | 550x67x35 mm  | 1678lm | White         |
| 6004000141 | LOTA_40W_W_LED_3600 | 40 W  | 1163x67x35 mm | 3011lm | White         |
| 6004000142 | LOTA_54W_W_LED_5000 | 54W   | 1705x67x35 mm | 4689lm | White         |
| 6004000143 | LOTA_72W_W_LED_6800 | 72W   | 2315x67x35 mm | 6022lm | White         |

MADE  
IN LTU
 IP40

IK05

CRI≥80

3000K  
6000K
 50000 h

 5  
WARRANTY

## SPECIFICATIONS

- Oblong, linear LED luminaire, hung on cables (max 1m long cables) or attached to the ceiling.
- Constant power electronic power supply.
- Housing: extruded anodized aluminum. End caps: extruded aluminum.
- The luminaire is painted with powder paint. Lens: acrylic.
- Can be produce with 3000K, 4500K or 6000K.

## MODELS

| CODE       | MODEL                       | POWER | DIMENSION     | LUMEN   | HOUSING COLOR |
|------------|-----------------------------|-------|---------------|---------|---------------|
| 6004000059 | LIMAN100_20W_G_LED_2000 CCT | 20W   | 585x55x75 mm  | 1700 lm | Grey          |
| 6004000060 | LIMAN100_40W_G_LED_4000 CCT | 40 W  | 1163x55x75 mm | 4000 lm | Grey          |
| 6004000061 | LIMAN100_60W_G_LED_6000 CCT | 60 W  | 1745x55x75 mm | 5700 lm | Grey          |
| 6004000062 | LIMAN100_80W_G_LED_8000 CCT | 80 W  | 2325x55x75 mm | 8000 lm | Grey          |
| 6004000063 | LIMAN100_20W_B_LED_2000 CCT | 20W   | 585x55x75 mm  | 1700 lm | Black         |
| 6004000064 | LIMAN100_40W_B_LED_4000 CCT | 40 W  | 1163x55x75 mm | 4000 lm | Black         |
| 6004000065 | LIMAN100_60W_B_LED_6000 CCT | 60 W  | 1745x55x75 mm | 5700 lm | Black         |
| 6004000066 | LIMAN100_80W_B_LED_8000 CCT | 80 W  | 2325x55x75 mm | 8000 lm | Black         |
| 6004000067 | LIMAN100_20W_W_LED_2000 CCT | 20W   | 585x55x75 mm  | 1700 lm | White         |
| 6004000068 | LIMAN100_40W_W_LED_4000 CCT | 40 W  | 1163x55x75 mm | 4000 lm | White         |
| 6004000069 | LIMAN100_60W_W_LED_6000 CCT | 60 W  | 1745x55x75 mm | 5700 lm | White         |
| 6004000070 | LIMAN100_80W_W_LED_8000 CCT | 80 W  | 2325x55x75 mm | 8000 lm | White         |



## LIMAN100\_0-10V\_DIMMABLE

- Dimmable: 0-10V



### MODELS

| CODE       | MODEL                             | POWER | DIMENSION     | LUMEN   | HOUSING COLOR |
|------------|-----------------------------------|-------|---------------|---------|---------------|
| 6004100060 | LIMAN100_40W_G_LED_4000_CCT_0-10V | 40 W  | 1163x55x75 mm | 4000 lm | Grey          |
| 6004100062 | LIMAN100_80W_G_LED_8000_CCT_0-10V | 80 W  | 2325x55x75 mm | 8000 lm | Grey          |
| 6004100064 | LIMAN100_40W_B_LED_4000_CCT_0-10V | 40 W  | 1163x55x75 mm | 4000 lm | Black         |
| 6004100066 | LIMAN100_80W_B_LED_8000_CCT_0-10V | 80 W  | 2325x55x75 mm | 8000 lm | Black         |
| 6004100068 | LIMAN100_40W_W_LED_4000_CCT_0-10V | 40 W  | 1163x55x75 mm | 4000 lm | White         |
| 6004100070 | LIMAN100_80W_W_LED_8000_CCT_0-10V | 80 W  | 2325x55x75 mm | 8000 lm | White         |

## LIMAN100\_TRIAC\_DIMMABLE

- Dimmable: TRIAC



### MODELS

| CODE       | MODEL                             | POWER | DIMENSION     | LUMEN   | HOUSING COLOR |
|------------|-----------------------------------|-------|---------------|---------|---------------|
| 6004300060 | LIMAN100_40W_G_LED_4000_CCT_TRIAC | 40 W  | 1163x55x75 mm | 4000 lm | Grey          |
| 6004300062 | LIMAN100_80W_G_LED_8000_CCT_TRIAC | 80 W  | 2325x55x75 mm | 8000 lm | Grey          |
| 6004300064 | LIMAN100_40W_B_LED_4000_CCT_TRIAC | 40 W  | 1163x55x75 mm | 4000 lm | Black         |
| 6004300066 | LIMAN100_80W_B_LED_8000_CCT_TRIAC | 80 W  | 2325x55x75 mm | 8000 lm | Black         |
| 6004300068 | LIMAN100_40W_W_LED_4000_CCT_TRIAC | 40 W  | 1163x55x75 mm | 4000 lm | White         |
| 6004300070 | LIMAN100_80W_W_LED_8000_CCT_TRIAC | 80 W  | 2325x55x75 mm | 8000 lm | White         |

## LIMAN100\_WITH REMOTE CONTROL

- The luminaire is controlled by a remote control (remote control not included to the set).



### MODELS

| CODE       | MODEL                          | POWER | DIMENSION     | LUMEN   | HOUSING COLOR |
|------------|--------------------------------|-------|---------------|---------|---------------|
| 6004600060 | LIMAN100_40W_G_LED_4000_CCT_RC | 40 W  | 1163x55x75 mm | 4000 lm | Grey          |
| 6004600062 | LIMAN100_80W_G_LED_8000_CCT_RC | 80 W  | 2325x55x75 mm | 8000 lm | Grey          |
| 6004600064 | LIMAN100_40W_B_LED_4000_CCT_RC | 40 W  | 1163x55x75 mm | 4000 lm | Black         |
| 6004600066 | LIMAN100_80W_B_LED_8000_CCT_RC | 80 W  | 2325x55x75 mm | 8000 lm | Black         |
| 6004600068 | LIMAN100_40W_W_LED_4000_CCT_RC | 40 W  | 1163x55x75 mm | 4000 lm | White         |
| 6004600070 | LIMAN100_80W_W_LED_8000_CCT_RC | 80 W  | 2325x55x75 mm | 8000 lm | White         |
| 6004610001 | LIMAN100_EASY_RF_REMOTE        |       |               |         |               |

## LIMAN100\_DALI

• Dimmable: DALI



### MODELS

| CODE       | MODEL                            | POWER | DIMENSION     | LUMEN   | HOUSING COLOR |
|------------|----------------------------------|-------|---------------|---------|---------------|
| 6004400060 | LIMAN100_40W_G_LED_4000_CCT_DALI | 40 W  | 1163x55x75 mm | 4000 lm | Grey          |
| 6004400062 | LIMAN100_80W_G_LED_8000_CCT_DALI | 80 W  | 2325x55x75 mm | 8000 lm | Grey          |
| 6004400064 | LIMAN100_40W_B_LED_4000_CCT_DALI | 40 W  | 1163x55x75 mm | 4000 lm | Black         |
| 6004400066 | LIMAN100_80W_B_LED_8000_CCT_DALI | 80 W  | 2325x55x75 mm | 8000 lm | Black         |
| 6004400068 | LIMAN100_40W_W_LED_4000_CCT_DALI | 40 W  | 1163x55x75 mm | 4000 lm | White         |
| 6004400070 | LIMAN100_80W_W_LED_8000_CCT_DALI | 80 W  | 2325x55x75 mm | 8000 lm | White         |

## LIMAN100\_SENSOR

• Completed with motion sensor.



### MODELS

| CODE       | MODEL                            | POWER | DIMENSION     | LUMEN   | HOUSING COLOR |
|------------|----------------------------------|-------|---------------|---------|---------------|
| 6004700059 | LIMAN100_20W_G_LED_2000_CCT_SENS | 20W   | 585x55x75 mm  | 1700 lm | Grey          |
| 6004700060 | LIMAN100_40W_G_LED_4000_CCT_SENS | 40 W  | 1163x55x75 mm | 4000 lm | Grey          |
| 6004700061 | LIMAN100_60W_G_LED_6000_CCT_SENS | 60 W  | 1745x55x75 mm | 5700 lm | Grey          |
| 6004700062 | LIMAN100_80W_G_LED_8000_CCT_SENS | 80 W  | 2325x55x75 mm | 8000 lm | Grey          |
| 6004700063 | LIMAN100_20W_B_LED_2000_CCT_SENS | 20W   | 585x55x75 mm  | 1700 lm | Black         |
| 6004700064 | LIMAN100_40W_B_LED_4000_CCT_SENS | 40 W  | 1163x55x75 mm | 4000 lm | Black         |
| 6004700065 | LIMAN100_60W_B_LED_6000_CCT_SENS | 60 W  | 1745x55x75 mm | 5700 lm | Black         |
| 6004700066 | LIMAN100_80W_B_LED_8000_CCT_SENS | 80 W  | 2325x55x75 mm | 8000 lm | Black         |
| 6004700067 | LIMAN100_20W_W_LED_2000_CCT_SENS | 20W   | 585x55x75 mm  | 1700 lm | White         |
| 6004700068 | LIMAN100_40W_W_LED_4000_CCT_SENS | 40 W  | 1163x55x75 mm | 4000 lm | White         |
| 6004700069 | LIMAN100_60W_W_LED_6000_CCT_SENS | 60 W  | 1745x55x75 mm | 5700 lm | White         |
| 6004700070 | LIMAN100_80W_W_LED_8000_CCT_SENS | 80 W  | 2325x55x75 mm | 8000 lm | White         |

## LIMAN100\_EMERGENCY

• Completed with emergency block (2h).



### MODELS

| CODE       | MODEL                          | POWER | DIMENSION     | LUMEN   | EM. LUMENS    | WORKING TIME | HOUSING COLOR |
|------------|--------------------------------|-------|---------------|---------|---------------|--------------|---------------|
| 6004200059 | LIMAN100_20W_G_LED_2000_CCT_EM | 20W   | 585x55x75 mm  | 1700 lm | max 387,96 lm | 2h           | Grey          |
| 6004200060 | LIMAN100_40W_G_LED_4000_CCT_EM | 40 W  | 1163x55x75 mm | 4000 lm | max 387,96 lm | 2h           | Grey          |
| 6004200061 | LIMAN100_60W_G_LED_6000_CCT_EM | 60 W  | 1745x55x75 mm | 5700 lm | max 387,96 lm | 2h           | Grey          |
| 6004200062 | LIMAN100_80W_G_LED_8000_CCT_EM | 80 W  | 2325x55x75 mm | 8000 lm | max 387,96 lm | 2h           | Grey          |
| 6004200063 | LIMAN100_20W_B_LED_2000_CCT_EM | 20W   | 585x55x75 mm  | 1700 lm | max 387,96 lm | 2h           | Black         |
| 6004200064 | LIMAN100_40W_B_LED_4000_CCT_EM | 40 W  | 1163x55x75 mm | 4000 lm | max 387,96 lm | 2h           | Black         |
| 6004200065 | LIMAN100_60W_B_LED_6000_CCT_EM | 60 W  | 1745x55x75 mm | 5700 lm | max 387,96 lm | 2h           | Black         |
| 6004200066 | LIMAN100_80W_B_LED_8000_CCT_EM | 80 W  | 2325x55x75 mm | 8000 lm | max 387,96 lm | 2h           | Black         |
| 6004200067 | LIMAN100_20W_W_LED_2000_CCT_EM | 20W   | 585x55x75 mm  | 1700 lm | max 387,96 lm | 2h           | White         |
| 6004200068 | LIMAN100_40W_W_LED_4000_CCT_EM | 40 W  | 1163x55x75 mm | 4000 lm | max 387,96 lm | 2h           | White         |
| 6004200069 | LIMAN100_60W_W_LED_6000_CCT_EM | 60 W  | 1745x55x75 mm | 5700 lm | max 387,96 lm | 2h           | White         |
| 6004200070 | LIMAN100_80W_W_LED_8000_CCT_EM | 80 W  | 2325x55x75 mm | 8000 lm | max 387,96 lm | 2h           | White         |



|                |      |      |        |                |         |               |
|----------------|------|------|--------|----------------|---------|---------------|
| MADE<br>IN LTU | IP40 | IK05 | CRI≥80 | 3000K<br>6000K | 50000 h | 5<br>WARRANTY |
|----------------|------|------|--------|----------------|---------|---------------|

## SPECIFICATIONS

- Oblong, linear LED luminaire, hung on cables (max 1m long cables) or attached to the ceiling.
- Constant power electronic power supply.
- Housing: extruded anodized aluminum. End caps: extruded aluminum.
- The luminaire is painted with powder paint. Lens: acrylic.
- Can be produce with 3000K, 4500K or 6000K.

## MODELS

| CODE       | MODEL                            | POWER | DIMENSION     | LUMEN    | HOUSING COLOR |
|------------|----------------------------------|-------|---------------|----------|---------------|
| 6004500059 | LIMAN100_40W_G_LED_4000_CCT_HP   | 40 W  | 585x55x75 mm  | 3400 lm  | Grey          |
| 6004500060 | LIMAN100_80W_G_LED_8000_CCT_HP   | 80 W  | 1163x55x75 mm | 8000 lm  | Grey          |
| 6004500061 | LIMAN100_120W_G_LED_12000_CCT_HP | 120W  | 1745x55x75 mm | 11400 lm | Grey          |
| 6004500062 | LIMAN100_160W_G_LED_16000_CCT_HP | 160W  | 2325x55x75 mm | 16000 lm | Grey          |
| 6004500063 | LIMAN100_40W_B_LED_4000_CCT_HP   | 40 W  | 585x55x75 mm  | 3400 lm  | Black         |
| 6004500064 | LIMAN100_80W_B_LED_8000_CCT_HP   | 80 W  | 1163x55x75 mm | 8000 lm  | Black         |
| 6004500065 | LIMAN100_120W_B_LED_12000_CCT_HP | 120W  | 1745x55x75 mm | 11400 lm | Black         |
| 6004500066 | LIMAN100_160W_B_LED_16000_CCT_HP | 160W  | 2325x55x75 mm | 16000 lm | Black         |
| 6004500067 | LIMAN100_40W_W_LED_4000_CCT_HP   | 40 W  | 585x55x75 mm  | 3400 lm  | White         |
| 6004500068 | LIMAN100_80W_W_LED_8000_CCT_HP   | 80 W  | 1163x55x75 mm | 8000 lm  | White         |
| 6004500069 | LIMAN100_120W_W_LED_12000_CCT_HP | 120 W | 1745x55x75 mm | 11400 lm | White         |
| 6004500070 | LIMAN100_160W_W_LED_16000_CCT_HP | 160W  | 2325x55x75 mm | 16000 lm | White         |

## LIMAN100\_HIGH POWER\_0-10V\_DIMMABLE

- Dimmable: 0-10V



### MODELS

| CODE       | MODEL                                  | POWER | DIMENSION     | LUMEN    | HOUSING COLOR |
|------------|--|-------|---------------|----------|---------------|
| 6004510060 | LIMAN100_80W_G_LED_8000_CCT_HP_0-10V   | 80 W  | 1163x55x75 mm | 8000 lm  | Grey          |
| 6004510062 | LIMAN100_160W_G_LED_16000_CCT_HP_0-10V | 160W  | 2325x55x75 mm | 16000 lm | Grey          |
| 6004510064 | LIMAN100_80W_B_LED_8000_CCT_HP_0-10V   | 80 W  | 1163x55x75 mm | 8000 lm  | Black         |
| 6004510066 | LIMAN100_160W_B_LED_16000_CCT_HP_0-10V | 160W  | 2325x55x75 mm | 16000 lm | Black         |
| 6004510068 | LIMAN100_80W_W_LED_8000_CCT_HP_0-10V   | 80 W  | 1163x55x75 mm | 8000 lm  | White         |
| 6004510070 | LIMAN100_160W_W_LED_16000_CCT_HP_0-10V | 160W  | 2325x55x75 mm | 16000 lm | White         |

## LIMAN100\_HIGH POWER\_SENSOR

- Completed with motion sensor.



### MODELS

| CODE       | MODEL                            | POWER | DIMENSION     | LUMEN    | HOUSING COLOR |
|------------|----------------------------------|-------|---------------|----------|---------------|
| 6004570059 | LIMAN100_40W_G_LED_4000_CCT_HP   | 40 W  | 585x55x75 mm  | 3400 lm  | Grey          |
| 6004570060 | LIMAN100_80W_G_LED_8000_CCT_HP   | 80 W  | 1163x55x75 mm | 8000 lm  | Grey          |
| 6004570061 | LIMAN100_120W_G_LED_12000_CCT_HP | 120W  | 1745x55x75 mm | 11400 lm | Grey          |
| 6004570062 | LIMAN100_160W_G_LED_16000_CCT_HP | 160W  | 2325x55x75 mm | 16000 lm | Grey          |
| 6004570063 | LIMAN100_40W_B_LED_4000_CCT_HP   | 40 W  | 585x55x75 mm  | 3400 lm  | Black         |
| 6004570064 | LIMAN100_80W_B_LED_8000_CCT_HP   | 80 W  | 1163x55x75 mm | 8000 lm  | Black         |
| 6004570065 | LIMAN100_120W_B_LED_12000_CCT_HP | 120W  | 1745x55x75 mm | 11400 lm | Black         |
| 6004570066 | LIMAN100_160W_B_LED_16000_CCT_HP | 160W  | 2325x55x75 mm | 16000 lm | Black         |
| 6004570067 | LIMAN100_40W_W_LED_4000_CCT_HP   | 40 W  | 585x55x75 mm  | 3400 lm  | White         |
| 6004570068 | LIMAN100_80W_W_LED_8000_CCT_HP   | 80 W  | 1163x55x75 mm | 8000 lm  | White         |
| 6004570069 | LIMAN100_120W_W_LED_12000_CCT_HP | 120 W | 1745x55x75 mm | 11400 lm | White         |
| 6004570070 | LIMAN100_160W_W_LED_16000_CCT_HP | 160W  | 2325x55x75 mm | 16000 lm | White         |

## LIMAN100\_HIGH POWER\_EMERGENCY

- Completed with emergency block (2h).



### MODELS

| CODE       | MODEL                               | POWER | DIMENSION     | LUMEN    | EM. LUMENS    | EM. WORKING TIME | HOUSING COLOR |
|------------|-------------------------------------|-------|---------------|----------|---------------|------------------|---------------|
| 6004520059 | LIMAN100_40W_G_LED_4000_CCT_HP_EM   | 40 W  | 585x55x75 mm  | 3400 lm  | max 387,96 lm | 2h               | Grey          |
| 6004520060 | LIMAN100_80W_G_LED_8000_CCT_HP_EM   | 80 W  | 1163x55x75 mm | 8000 lm  | max 387,96 lm | 2h               | Grey          |
| 6004520061 | LIMAN100_120W_G_LED_12000_CCT_HP_EM | 120 W | 1745x55x75 mm | 11400 lm | max 387,96 lm | 2h               | Grey          |
| 6004520062 | LIMAN100_160W_G_LED_16000_CCT_HP_EM | 160W  | 2325x55x75 mm | 16000 lm | max 387,96 lm | 2h               | Grey          |
| 6004520063 | LIMAN100_40W_B_LED_4000_CCT_HP_EM   | 40 W  | 585x55x75 mm  | 3400 lm  | max 387,96 lm | 2h               | Black         |
| 6004520064 | LIMAN100_80W_B_LED_8000_CCT_HP_EM   | 80 W  | 1163x55x75 mm | 8000 lm  | max 387,96 lm | 2h               | Black         |
| 6004520065 | LIMAN100_120W_B_LED_12000_CCT_HP_EM | 120 W | 1745x55x75 mm | 11400 lm | max 387,96 lm | 2h               | Black         |
| 6004520066 | LIMAN100_160W_B_LED_16000_CCT_HP_EM | 160W  | 2325x55x75 mm | 16000 lm | max 387,96 lm | 2h               | Black         |
| 6004520067 | LIMAN100_40W_W_LED_4000_CCT_HP_EM   | 40 W  | 585x55x75 mm  | 3400 lm  | max 387,96 lm | 2h               | White         |
| 6004520068 | LIMAN100_80W_W_LED_8000_CCT_HP_EM   | 80 W  | 1163x55x75 mm | 8000 lm  | max 387,96 lm | 2h               | White         |
| 6004520069 | LIMAN100_120W_W_LED_12000_CCT_HP_EM | 120 W | 1745x55x75 mm | 11400 lm | max 387,96 lm | 2h               | White         |
| 6004520070 | LIMAN100_160W_W_LED_16000_CCT_HP_EM | 160W  | 2325x55x75 mm | 16000 lm | max 387,96 lm | 2h               | White         |

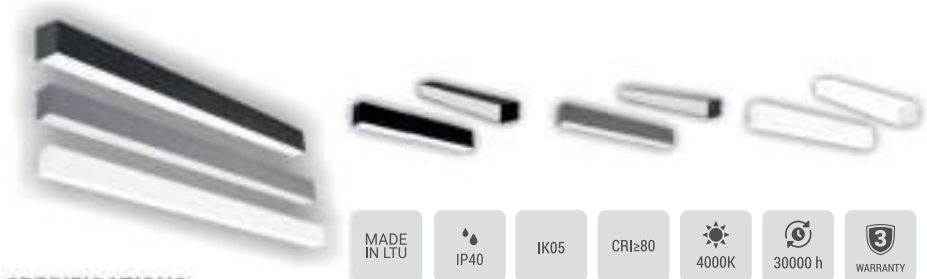

## SPECIFICATIONS

- Oblong, linear LED luminaire, hung on cables (max 1m long cables) or attached to the ceiling.
- Constant power electronic power supply.
- Housing: extruded anodized aluminum. End caps: extruded aluminum.
- The luminaire is painted with powder paint. Lens: acrylic.
- Complete with 4000K

## MODELS

| CODE       | MODEL                   | POWER | DIMENSION     | LUMEN   | HOUSING COLOR |
|------------|-------------------------|-------|---------------|---------|---------------|
| 6004000035 | LIMAN100_20W_G_LED_1800 | 20W   | 550x55x75 mm  | 1678 lm | Grey          |
| 6004000036 | LIMAN100_40W_G_LED_3600 | 40W   | 1163x55x75 mm | 3011 lm | Grey          |
| 6004000037 | LIMAN100_54W_G_LED_5000 | 54 W  | 1705x55x75 mm | 4689 lm | Grey          |
| 6004000038 | LIMAN100_72W_G_LED_6800 | 72W   | 2315x55x75 mm | 6022 lm | Grey          |
| 6004000039 | LIMAN100_20W_B_LED_1800 | 20W   | 550x55x75 mm  | 1678 lm | Black         |
| 6004000040 | LIMAN100_40W_B_LED_3600 | 40W   | 1163x55x75 mm | 3011 lm | Black         |
| 6004000041 | LIMAN100_54W_B_LED_5000 | 54 W  | 1705x55x75 mm | 4689 lm | Black         |
| 6004000042 | LIMAN100_72W_B_LED_6800 | 72W   | 2315x55x75 mm | 6022 lm | Black         |
| 6004000043 | LIMAN100_20W_W_LED_1800 | 20W   | 550x55x75 mm  | 1678 lm | White         |
| 6004000044 | LIMAN100_40W_W_LED_3600 | 40W   | 1163x55x75 mm | 3011 lm | White         |
| 6004000045 | LIMAN100_54W_W_LED_5000 | 54 W  | 1705x55x75 mm | 4689 lm | White         |
| 6004000046 | LIMAN100_72W_W_LED_6800 | 72W   | 2315x55x75 mm | 6022 lm | White         |

## LIMAN\_EMERGENCY

- Completed with emergency block (2h).



## MODELS

| CODE       | MODEL                      | POWER | DIMENSION     | LUMEN   | EM. LUMENS    | EM. WORKING TIME | HOUSING COLOR |
|------------|----------------------------|-------|---------------|---------|---------------|------------------|---------------|
| 6004200035 | LIMAN100_20W_G_LED_1800EM  | 20 W  | 550x55x75 mm  | 1678 lm | max 364,96 lm | 2h               | Grey          |
| 6004200036 | LIMAN100_40W_G_LED_3600_EM | 40W   | 1163x55x75 mm | 3011 lm | max 364,96 lm | 2h               | Grey          |
| 6004200037 | LIMAN100_54W_G_LED_5000_EM | 54 W  | 1705x55x75 mm | 4689 lm | max 364,96 lm | 2h               | Grey          |
| 6004200038 | LIMAN100_72W_G_LED_6800_EM | 72W   | 2315x55x75 mm | 6022 lm | max 364,96 lm | 2h               | Grey          |
| 6004200039 | LIMAN100_20W_B_LED_1800_EM | 20 W  | 550x55x75 mm  | 1678 lm | max 364,96 lm | 2h               | Black         |
| 6004200040 | LIMAN100_40W_B_LED_3600_EM | 40W   | 1163x55x75 mm | 3011 lm | max 364,96 lm | 2h               | Black         |
| 6004200041 | LIMAN100_54W_B_LED_5000_EM | 54 W  | 1705x55x75 mm | 4689 lm | max 364,96 lm | 2h               | Black         |
| 6004200042 | LIMAN100_72W_B_LED_6800_EM | 72W   | 2315x55x75 mm | 6022 lm | max 364,96 lm | 2h               | Black         |
| 6004200043 | LIMAN100_20W_W_LED_1800_EM | 20 W  | 550x55x75 mm  | 1678 lm | max 364,96 lm | 2h               | White         |
| 6004200044 | LIMAN100_40W_W_LED_3600_EM | 40W   | 1163x55x75 mm | 3011 lm | max 364,96 lm | 2h               | White         |
| 6004200045 | LIMAN100_54W_W_LED_5000_EM | 54 W  | 1705x55x75 mm | 4689 lm | max 364,96 lm | 2h               | White         |
| 6004200046 | LIMAN100_72W_W_LED_6800_EM | 72W   | 2315x55x75 mm | 6022 lm | max 364,96 lm | 2h               | White         |

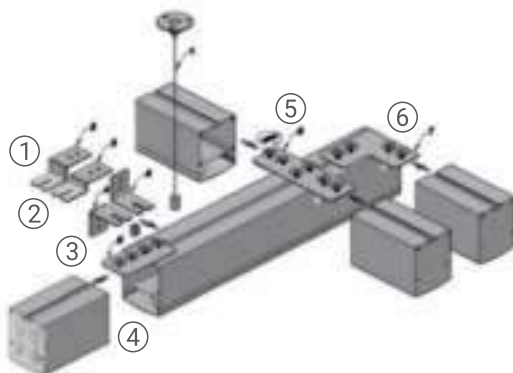

| CODE         | NAME   |
|--------------|--|
| ① 6004300001 | MOUNTING THE LUMINAIRE 22mm FROM THE CEILING |
| ② 6004300002 | MOUNTING THE LUMINAIRE 14mm FROM THE CEILING |
| ③ 6004300003 | MOUNTING THE LUMINAIRE ON THE WALL           |
| ④ 6004300004 | COMBINATION OF THE SEVERAL LUMINAIRES        |
| ⑤ 6004300005 | COMBINATIO OF THE LUMINAIRES 2x90°           |
| ⑥ 6004300006 | COMBINATION OF THE LUMINAIRES 90°            |

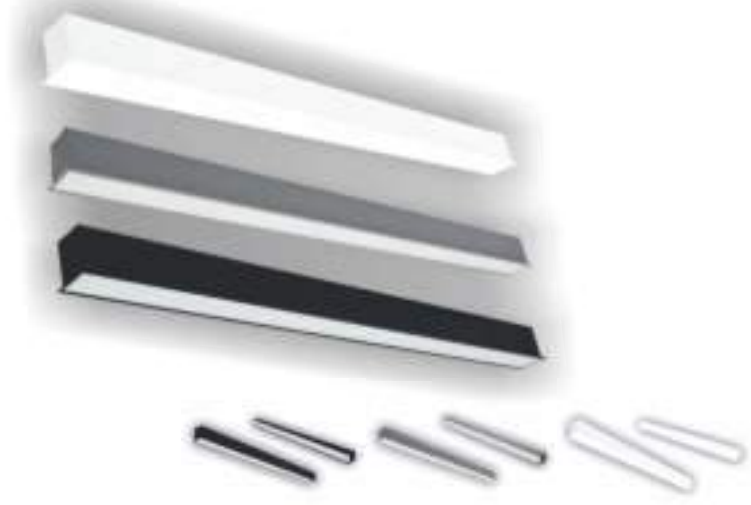

MADE  
IN LTU

  
IP40

IK05

CRI≥80

3000K  
6000K

  
50000 h

  
5  
WARRANTY

## SPECIFICATIONS

- Single length recessed suspended individual direct LED luminaire, with a seamless rectangular shape.
- Electronic, fixed output gear. Class I electrical, IP40.
- Body: extruded anodised Aluminum. End caps: die-cast aluminum, powder coated white, black or grey. Possibility to choose other color.
- Diffuser: acrylic. Supplied with adjustable wire suspension mounting.
- Can be produce with 3000K, 4500K or 6000K.

## MODELS

| CODE       | MODEL                      | POWER | DIMENSION     | LUMEN   | HOUSING COLOR |
|------------|----------------------------|-------|---------------|---------|---------------|
| 6003000064 | ESNA100_20W_G_LED_2000_CCT | 20W   | 599x71x75 mm  | 1700 lm | Grey          |
| 6003000065 | ESNA100_40W_G_LED_4000_CCT | 40 W  | 1174x71x75 mm | 4000 lm | Grey          |
| 6003000066 | ESNA100_60W_G_LED_6000_CCT | 60 W  | 1759x71x75 mm | 5700 lm | Grey          |
| 6003000067 | ESNA100_80W_G_LED_8000_CCT | 80 W  | 2339x71x75 mm | 8000 lm | Grey          |
| 6003000068 | ESNA100_20W_B_LED_2000_CCT | 20W   | 599x71x75 mm  | 1700 lm | Black         |
| 6003000069 | ESNA100_40W_B_LED_4000_CCT | 40 W  | 1174x71x75 mm | 4000 lm | Black         |
| 6003000070 | ESNA100_60W_B_LED_6000_CCT | 60 W  | 1759x71x75 mm | 5700 lm | Black         |
| 6003000071 | ESNA100_80W_B_LED_8000_CCT | 80 W  | 2339x71x75 mm | 8000 lm | Black         |
| 6003000072 | ESNA100_20W_W_LED_2000_CCT | 20W   | 599x71x75 mm  | 1700 lm | White         |
| 6003000073 | ESNA100_40W_W_LED_4000_CCT | 40 W  | 1174x71x75 mm | 4000 lm | White         |
| 6003000074 | ESNA100_60W_W_LED_6000_CCT | 60 W  | 1759x71x75 mm | 5700 lm | White         |
| 6003000075 | ESNA100_80W_W_LED_8000_CCT | 80 W  | 2339x71x75 mm | 8000 lm | White         |

## ESNA100\_0-10V\_DIMMABLE

• Dimmable: 0-10V



### MODELS

| CODE       | MODEL                            | POWER | DIMENSION     | LUMEN   | HOUSING COLOR |
|------------|----------------------------------|-------|---------------|---------|---------------|
| 6003100065 | ESNA100_40W_G_LED_4000_CCT_0-10V | 40 W  | 1174x71x75 mm | 4000 lm | Grey          |
| 6003100067 | ESNA100_80W_G_LED_8000_CCT_0-10V | 80 W  | 2339x71x75 mm | 8000 lm | Grey          |
| 6003100069 | ESNA100_40W_B_LED_4000_CCT_0-10V | 40 W  | 1174x71x75 mm | 4000 lm | Black         |
| 6003100071 | ESNA100_80W_B_LED_8000_CCT_0-10V | 80 W  | 2339x71x75 mm | 8000 lm | Black         |
| 6003100073 | ESNA100_40W_W_LED_4000_CCT_0-10V | 40 W  | 1174x71x75 mm | 4000 lm | White         |
| 6003100075 | ESNA100_80W_W_LED_8000_CCT_0-10V | 80 W  | 2339x71x75 mm | 8000 lm | White         |

## ESNA100\_TRIAC\_DIMMABLE

• Dimmable: TRIAC



### MODELS

| CODE       | MODEL                            | POWER | DIMENSION     | LUMEN   | HOUSING COLOR |
|------------|----------------------------------|-------|---------------|---------|---------------|
| 6003300065 | ESNA100_40W_G_LED_4000_CCT_TRIAC | 40 W  | 1174x71x75 mm | 4000 lm | Grey          |
| 6003300067 | ESNA100_80W_G_LED_8000_CCT_TRIAC | 80 W  | 2339x71x75 mm | 8000 lm | Grey          |
| 6003300069 | ESNA100_40W_B_LED_4000_CCT_TRIAC | 40 W  | 1174x71x75 mm | 4000 lm | Black         |
| 6003300071 | ESNA100_80W_B_LED_8000_CCT_TRIAC | 80 W  | 2339x71x75 mm | 8000 lm | Black         |
| 6003300073 | ESNA100_40W_W_LED_4000_CCT_TRIAC | 40 W  | 1174x71x75 mm | 4000 lm | White         |
| 6003300075 | ESNA100_80W_W_LED_8000_CCT_TRIAC | 80 W  | 2339x71x75 mm | 8000 lm | White         |

## ESNA100\_WITH REMOTE CONTROL

• The luminaire is controlled by a remote control (remote control not included to the set).



### MODELS

| CODE       | MODEL                         | POWER | DIMENSION     | LUMEN   | HOUSING COLOR |
|------------|-------------------------------|-------|---------------|---------|---------------|
| 6003600065 | ESNA100_40W_G_LED_4000_CCT_RC | 40 W  | 1174x71x75 mm | 4000 lm | Grey          |
| 6003600067 | ESNA100_80W_G_LED_8000_CCT_RC | 80 W  | 2339x71x75 mm | 8000 lm | Grey          |
| 6003600069 | ESNA100_40W_B_LED_4000_CCT_RC | 40 W  | 1174x71x75 mm | 4000 lm | Black         |
| 6003600071 | ESNA100_80W_B_LED_8000_CCT_RC | 80 W  | 2339x71x75 mm | 8000 lm | Black         |
| 6003600073 | ESNA100_40W_W_LED_4000_CCT_RC | 40 W  | 1174x71x75 mm | 4000 lm | White         |
| 6003600075 | ESNA100_80W_W_LED_8000_CCT_RC | 80 W  | 2339x71x75 mm | 8000 lm | White         |



## ESNA100\_DALI

- Dimmable with remote control (remote control not included to the set).



### MODELS

| CODE       | MODEL                           | POWER | DIMENSION     | LUMEN   | HOUSING COLOR |
|------------|---------------------------------|-------|---------------|---------|---------------|
| 3003400065 | ESNA100_40W_G_LED_4000_CCT_DALI | 40 W  | 585x71x75 mm  | 4000 lm | Grey          |
| 6003400067 | ESNA100_80W_G_LED_8000_CCT_DALI | 80 W  | 2339x71x75 mm | 8000 lm | Grey          |
| 3003400069 | ESNA100_40W_B_LED_4000_CCT_DALI | 40 W  | 585x71x75 mm  | 4000 lm | Black         |
| 6003400071 | ESNA100_80W_B_LED_8000_CCT_DALI | 80 W  | 2339x71x75 mm | 8000 lm | Black         |
| 6003400073 | ESNA100_40W_W_LED_4000_CCT_DALI | 40 W  | 585x71x75 mm  | 4000 lm | White         |
| 6003400075 | ESNA100_80W_W_LED_8000_CCT_DALI | 80 W  | 2339x71x75 mm | 8000 lm | White         |

## ESNA100\_EMERGENCY

- Completed with emergency block (2h).



### MODELS

| CODE       | MODEL                         | POWER | DIMENSION     | LUMEN   | EM. LUMENS | EM. WORKING TIME | HOUSING COLOR |
|------------|-------------------------------|-------|---------------|---------|------------|------------------|---------------|
| 6003200064 | ESNA100_20W_G_LED_2000_CCT_EM | 20 W  | 599x71x75 mm  | 1700 lm | max 388 lm | 2h               | Grey          |
| 6003200065 | ESNA100_40W_G_LED_4000_CCT_EM | 40 W  | 1174x71x75 mm | 4000 lm | max 388 lm | 2h               | Grey          |
| 6003200066 | ESNA100_60W_G_LED_6000_CCT_EM | 60 W  | 1795x71x75 mm | 5700 lm | max 388 lm | 2h               | Grey          |
| 6003200067 | ESNA100_80W_G_LED_8000_CCT_EM | 80 W  | 2339x71x75 mm | 8000 lm | max 388 lm | 2h               | Grey          |
| 6003200068 | ESNA100_20W_B_LED_2000_CCT_EM | 20 W  | 599x71x75 mm  | 1700 lm | max 388 lm | 2h               | Black         |
| 6003200069 | ESNA100_40W_B_LED_4000_CCT_EM | 40 W  | 1174x71x75 mm | 4000 lm | max 388 lm | 2h               | Black         |
| 6003200070 | ESNA100_60W_B_LED_6000_CCT_EM | 60 W  | 1759x71x75 mm | 5700 lm | max 388 lm | 2h               | Black         |
| 6003200071 | ESNA100_80W_B_LED_8000_CCT_EM | 80 W  | 2339x71x75 mm | 8000 lm | max 388 lm | 2h               | Black         |
| 6003200072 | ESNA100_20W_W_LED_2000_CCT_EM | 20 W  | 599x71x75 mm  | 1700 lm | max 388 lm | 2h               | White         |
| 6003200073 | ESNA100_40W_W_LED_4000_CCT_EM | 40 W  | 1174x71x75 mm | 4000 lm | max 388 lm | 2h               | White         |
| 6003200074 | ESNA100_60W_W_LED_6000_CCT_EM | 60 W  | 1759x71x75 mm | 5700 lm | max 388 lm | 2h               | White         |
| 6003200075 | ESNA100_80W_W_LED_8000_CCT_EM | 80 W  | 2339x71x75 mm | 8000 lm | max 388 lm | 2h               | White         |

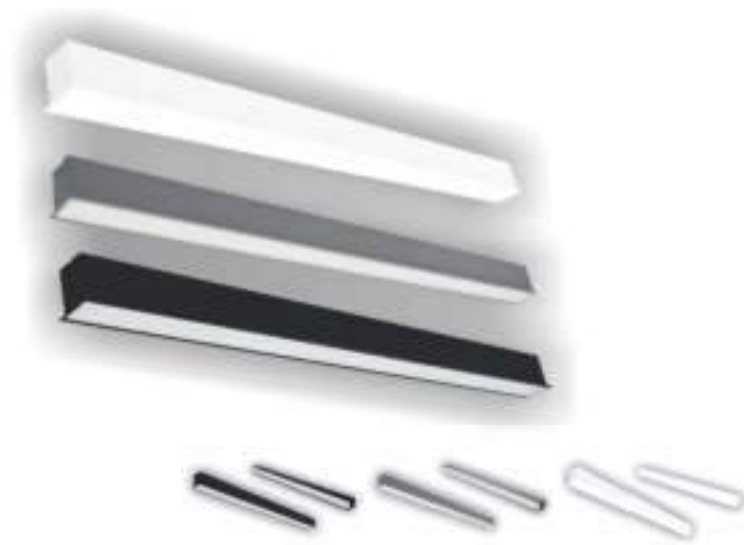

MADE  
IN LTU

IP40

IK05

CRI≥80

3000K  
6000K

50000 h

5  
WARRANTY

**SPECIFICATIONS**

- Single length recessed suspended individual direct LED luminaire, with a seamless rectangular shape.
- Electronic, fixed output gear. Class I electrical, IP40.
- Body: extruded anodised Aluminum. End caps: die-cast aluminum, powder coated white, black or grey. Possibility to choose other color.
- Diffuser: acrylic. Supplied with adjustable wire suspension mounting.
- Can be produce with 3000K, 4500K or 6000K.

**MODELS**

| CODE       | MODEL                           | POWER | DIMENSION     | LUMEN    | HOUSING COLOR |
|------------|---------------------------------|-------|---------------|----------|---------------|
| 6003500064 | ESNA100_40W_G_LED_4000_CCT_HP   | 40 W  | 585x71x75 mm  | 3400 lm  | Grey          |
| 6003500065 | ESNA100_80W_G_LED_8000_CCT_HP   | 80 W  | 1174x71x75 mm | 8000 lm  | Grey          |
| 6003500066 | ESNA100_120W_G_LED_12000_CCT_HP | 120 W | 1759x71x75 mm | 11400 lm | Grey          |
| 6003500067 | ESNA100_160W_G_LED_16000_CCT_HP | 160W  | 2339x71x75 mm | 16000 lm | Grey          |
| 6003500068 | ESNA100_40W_B_LED_4000_CCT_HP   | 40 W  | 585x71x75 mm  | 3400 lm  | Black         |
| 6003500069 | ESNA100_80W_B_LED_8000_CCT_HP   | 80 W  | 1174x71x75 mm | 8000 lm  | Black         |
| 6003500070 | ESNA100_120W_B_LED_12000_CCT_HP | 120W  | 1795x71x75 mm | 11400 lm | Black         |
| 6003500071 | ESNA100_160W_B_LED_16000_CCT_HP | 160W  | 2339x71x75 mm | 16000 lm | Black         |
| 6003500072 | ESNA100_40W_W_LED_4000_CCT_HP   | 40 W  | 585x71x75 mm  | 3400 lm  | White         |
| 6003500073 | ESNA100_80W_W_LED_8000_CCT_HP   | 80 W  | 1174x71x75 mm | 8000 lm  | White         |
| 6003500074 | ESNA100_120W_W_LED_12000_CCT_HP | 120 W | 1759x71x75 mm | 11400 lm | White         |
| 6003500075 | ESNA100_160W_W_LED_16000_CCT_HP | 160W  | 2339x71x75 mm | 16000 lm | White         |



## ESNA100\_HIGH POWER\_0-10V\_DIMMABLE

- Dimmable: 0-10V



### MODELS

| CODE       | MODEL                                 | POWER | DIMENSION     | LUMEN    | HOUSING COLOR |
|------------|---------------------------------------|-------|---------------|----------|---------------|
| 6003510065 | ESNA100_80W_G_LED_8000_CCT_HP_0-10V   | 80 W  | 1174x71x75 mm | 8000 lm  | Grey          |
| 6003510067 | ESNA100_160W_G_LED_16000_CCT_HP_0-10V | 160W  | 2339x71x75 mm | 16000 lm | Grey          |
| 6003510069 | ESNA100_80W_B_LED_8000_CCT_HP_0-10V   | 80 W  | 1174x71x75 mm | 8000 lm  | Black         |
| 6003510071 | ESNA100_160W_B_LED_16000_CCT_HP_0-10V | 160W  | 2339x71x75 mm | 16000 lm | Black         |
| 6003510073 | ESNA100_80W_W_LED_8000_CCT_HP_0-10V   | 80 W  | 1174x71x75 mm | 8000 lm  | White         |
| 6003510075 | ESNA100_160W_W_LED_16000_CCT_HP_0-10V | 160W  | 2339x71x75 mm | 16000 lm | White         |

## ESNA100\_HIGH POWER\_EMERGENCY

- Completed with emergency block (2h).



### MODELS

| CODE       | MODEL                              | POWER | DIMENSION     | LUMEN    | EM. LUMENS | EM. WORKING TIME | HOUSING COLOR |
|------------|------------------------------------|-------|---------------|----------|------------|------------------|---------------|
| 6003520064 | ESNA100_40W_G_LED_4000_CCT_HP_EM   | 40 W  | 585x71x75 mm  | 3400 lm  | max 388 lm | 2h               | Grey          |
| 6003520065 | ESNA100_80W_G_LED_8000_CCT_HP_EM   | 80 W  | 1174x71x75 mm | 8000 lm  | max 388 lm | 2h               | Grey          |
| 6003520066 | ESNA100_120W_G_LED_12000_CCT_HP_EM | 120 W | 1759x71x75 mm | 11400 lm | max 388 lm | 2h               | Grey          |
| 6003520067 | ESNA100_160W_G_LED_16000_CCT_HP_EM | 160W  | 2339x71x75 mm | 16000 lm | max 388 lm | 2h               | Grey          |
| 6003520068 | ESNA100_40W_B_LED_4000_CCT_HP_EM   | 40 W  | 585x71x75 mm  | 3400 lm  | max 388 lm | 2h               | Black         |
| 6003520069 | ESNA100_80W_B_LED_8000_CCT_HP_EM   | 80 W  | 1174x71x75 mm | 8000 lm  | max 388 lm | 2h               | Black         |
| 6003520070 | ESNA100_120W_B_LED_12000_CCT_HP_EM | 120 W | 1759x71x75 mm | 11400 lm | max 388 lm | 2h               | Black         |
| 6003520071 | ESNA100_160W_B_LED_16000_CCT_HP_EM | 160W  | 2339x71x75 mm | 16000 lm | max 388 lm | 2h               | Black         |
| 6003520072 | ESNA100_40W_W_LED_4000_CCT_HP_EM   | 40 W  | 585x71x75 mm  | 3400 lm  | max 388 lm | 2h               | White         |
| 6003520073 | ESNA100_80W_W_LED_8000_CCT_HP_EM   | 80 W  | 1174x71x75 mm | 8000 lm  | max 388 lm | 2h               | White         |
| 6003520074 | ESNA100_120W_W_LED_12000_CCT_HP_EM | 120 W | 1759x71x75 mm | 11400 lm | max 388 lm | 2h               | White         |
| 6003520075 | ESNA100_160W_W_LED_16000_CCT_HP_EM | 160W  | 2339x71x75 mm | 16000 lm | max 388 lm | 2h               | White         |



**SPECIFICATIONS**

- Single length recessed suspended individual direct LED luminaire, with a seamless rectangular shape.
- Electronic, fixed output gear. Class I electrical, IP40.
- Body: extruded anodised Aluminum. End caps: die-cast aluminum, powder coated white, black or grey. Possibility to choose other color.
- Diffuser: acrylic. Supplied with adjustable wire suspension mounting.
- Complete with 4000K LED

MADE IN LTU IP40 IK05 CRI≥80 4000K 30000 h WARRANTY

**MODELS**

| CODE       | MODEL                  | POWER | DIMENSION     | LUMEN   | HOUSING COLOR |
|------------|------------------------|-------|---------------|---------|---------------|
| 6003000052 | ESNA100_20W_G_LED_1800 | 20W   | 575x71x75 mm  | 1678 lm | Grey          |
| 6003000053 | ESNA100_40W_G_LED_3600 | 40W   | 1178x71x75 mm | 3011 lm | Grey          |
| 6003000054 | ESNA100_54W_G_LED_5000 | 54 W  | 1722x71x75 mm | 4689 lm | Grey          |
| 6003000055 | ESNA100_72W_G_LED_6800 | 72W   | 2339x71x75 mm | 6022 lm | Grey          |
| 6003000056 | ESNA100_20W_B_LED_1800 | 20W   | 575x71x75 mm  | 1678 lm | Black         |
| 6003000057 | ESNA100_40W_B_LED_3600 | 40W   | 1178x71x75 mm | 3011 lm | Black         |
| 6003000058 | ESNA100_54W_B_LED_5000 | 54 W  | 1722x71x75 mm | 4689 lm | Black         |
| 6003000059 | ESNA100_72W_B_LED_6800 | 72W   | 2339x71x75 mm | 6022 lm | Black         |
| 6003000060 | ESNA100_20W_W_LED_1800 | 20W   | 575x71x75 mm  | 1678 lm | White         |
| 6003000061 | ESNA100_40W_W_LED_3600 | 40W   | 1178x71x75 mm | 3011 lm | White         |
| 6003000062 | ESNA100_54W_W_LED_5000 | 54 W  | 1722x71x75 mm | 4689 lm | White         |
| 6003000063 | ESNA100_72W_W_LED_6800 | 72W   | 2339x71x75 mm | 6022 lm | White         |

**ESNA\_EMERGENCY**

- Completed with emergency block (2h).

MADE IN LTU IP40 CRI≥80 4000K 30000 h WARRANTY

**MODELS**

| CODE       | MODEL                     | POWER | DIMENSION     | LUMEN   | EM. LUMENS | EM. WORKING TIME | HOUSING COLOR |
|------------|---------------------------|-------|---------------|---------|------------|------------------|---------------|
| 6003200052 | ESNA100_20W_G_LED_1800_EM | 20 W  | 575x71x75 mm  | 1678 lm | max 365 lm | 2h               | Grey          |
| 6003200053 | ESNA100_40W_G_LED_3600_EM | 40W   | 1178x71x75 mm | 3011 lm | max 365 lm | 2h               | Grey          |
| 6003200054 | ESNA100_54W_G_LED_5000_EM | 54 W  | 1722x71x75 mm | 4689 lm | max 365 lm | 2h               | Grey          |
| 6003200055 | ESNA100_72W_G_LED_6800_EM | 72W   | 2339x71x75 mm | 6022 lm | max 365 lm | 2h               | Grey          |
| 6003200056 | ESNA100_20W_B_LED_1800_EM | 20 W  | 575x71x75 mm  | 1678 lm | max 365 lm | 2h               | Black         |
| 6003200057 | ESNA100_40W_B_LED_3600_EM | 40W   | 1178x71x75 mm | 3011 lm | max 365 lm | 2h               | Black         |
| 6003200058 | ESNA100_54W_B_LED_5000_EM | 54 W  | 1722x71x75 mm | 4689 lm | max 365 lm | 2h               | Black         |
| 6003200059 | ESNA100_72W_B_LED_6800_EM | 72W   | 2339x71x75 mm | 6022 lm | max 365 lm | 2h               | Black         |
| 6003200060 | ESNA100_20W_W_LED_1800_EM | 20 W  | 575x71x75 mm  | 1678 lm | max 365 lm | 2h               | White         |
| 6003200061 | ESNA100_40W_W_LED_3600_EM | 40W   | 1178x71x75 mm | 3011 lm | max 365 lm | 2h               | White         |
| 6003200062 | ESNA100_54W_W_LED_5000_EM | 54 W  | 1722x71x75 mm | 4689 lm | max 365 lm | 2h               | White         |
| 6003200063 | ESNA100_72W_W_LED_6800_EM | 72W   | 2339x71x75 mm | 6022 lm | max 365 lm | 2h               | White         |



LED OUTDOOR  
LIGHT

**TOPE** LP  
**LIGHTING** LL

A modern hallway with white walls and light wood flooring. Two vertical LED light strips are mounted on the walls, one on the left and one on the right, both emitting a warm, yellowish glow. In the center of the hallway, a framed picture hangs on the wall. Below the picture, a stainless steel trash can is visible. The ceiling is white and appears to have recessed lighting. The overall atmosphere is clean and contemporary.

LED INDOOR  
LIGHT



IP54

IK08

CRI $\geq$ 903000K  
4000K

50000 h



WARRANTY

## SPECIFICATIONS

- A surface mounting LED linear luminaire for outdoor and indoor using, with a slim 1,5mm profile.
- Electronic, fixed output gear.
- Body: sheet steel white, black or grey.
- Diffuser: UV - stabilised, PRO-LINE optic. Electrical connection via push wire terminal block..
- Complete with 3000K or 4000K LED.

## MODELS

| CODE       | MODEL                  | POWER | DIMENSION | KELVIN      | HOUSING COLOR |
|------------|------------------------|-------|-----------|-------------|---------------|
| 6006000076 | TAMNA6_10W_W_LED_800   | 10W   | 600x80mm  | 3000K/4000K | White         |
| 6006000077 | TAMNA6_16W_W_LED_1280  | 16W   | 600x80mm  | 3000K/4000K | White         |
| 6006000078 | TAMNA12_12W_W_LED_960  | 12W   | 1200x80mm | 3000K/4000K | White         |
| 6006000079 | TAMNA12_24W_W_LED_1920 | 24W   | 1200x80mm | 3000K/4000K | White         |
| 6006000080 | TAMNA12_35W_W_LED_2800 | 35W   | 1200x80mm | 3000K/4000K | White         |
| 6006000081 | TAMNA16_15W_W_LED_1200 | 15W   | 1600x80mm | 3000K/4000K | White         |
| 6006000082 | TAMNA16_30W_W_LED_2400 | 30W   | 1600x80mm | 3000K/4000K | White         |
| 6006000083 | TAMNA16_45W_W_LED_3600 | 45W   | 1600x80mm | 3000K/4000K | White         |
| 6006000084 | TAMNA20_20W_W_LED_1600 | 20W   | 2000x80mm | 3000K/4000K | White         |
| 6006000085 | TAMNA20_40W_W_LED_3200 | 40W   | 2000x80mm | 3000K/4000K | White         |
| 6006000086 | TAMNA20_60W_W_LED_4800 | 60W   | 2000x80mm | 3000K/4000K | White         |
| 6006000087 | TAMNA24_22W_W_LED_1760 | 22W   | 2400x80mm | 3000K/4000K | White         |
| 6006000088 | TAMNA24_45W_W_LED_3600 | 45W   | 2400x80mm | 3000K/4000K | White         |



## SPECIFICATIONS

- A surface mounting LED linear luminaire for outdoor and indoor using, with a slim 1,5mm profile.
- Electronic, fixed output gear.
- Body: sheet steel white, black or grey.
- Diffuser: UV - stabilised, PRO-LINE optic. Electrical connection via push wire terminal block..
- Complete with 3000K or 4000K LED.

## MODELS

| CODE       | MODEL                  | POWER | DIMENSION | KELVIN      | HOUSING COLOR |
|------------|------------------------|-------|-----------|-------------|---------------|
| 6006000089 | TAMNA6_10W_B_LED_800   | 10W   | 600x80mm  | 3000K/4000K | Black         |
| 6006000090 | TAMNA6_16W_B_LED_1280  | 16W   | 600x80mm  | 3000K/4000K | Black         |
| 6006000091 | TAMNA12_12W_B_LED_960  | 12W   | 1200x80mm | 3000K/4000K | Black         |
| 6006000092 | TAMNA12_24W_B_LED_1920 | 24W   | 1200x80mm | 3000K/4000K | Black         |
| 6006000093 | TAMNA12_35W_B_LED_2800 | 35W   | 1200x80mm | 3000K/4000K | Black         |
| 6006000094 | TAMNA16_15W_B_LED_1200 | 15W   | 1600x80mm | 3000K/4000K | Black         |
| 6006000095 | TAMNA16_30W_B_LED_2400 | 30W   | 1600x80mm | 3000K/4000K | Black         |
| 6006000096 | TAMNA16_45W_B_LED_3600 | 45W   | 1600x80mm | 3000K/4000K | Black         |
| 6006000097 | TAMNA20_20W_B_LED_1600 | 20W   | 2000x80mm | 3000K/4000K | Black         |
| 6006000098 | TAMNA20_40W_B_LED_3200 | 40W   | 2000x80mm | 3000K/4000K | Black         |
| 6006000099 | TAMNA20_60W_B_LED_4800 | 60W   | 2000x80mm | 3000K/4000K | Black         |
| 6006000100 | TAMNA24_22W_B_LED_1760 | 22W   | 2400x80mm | 3000K/4000K | Black         |
| 6006000101 | TAMNA24_45W_B_LED_3600 | 45W   | 2400x80mm | 3000K/4000K | Black         |





IP54

IK08

CRI $\geq$ 903000K  
4000K

50000 h



WARRANTY

## SPECIFICATIONS

- A surface mounting LED linear luminaire for outdoor and indoor using, with a slim 1,5mm profile.
- Electronic, fixed output gear.
- Body: sheet steel white, black or grey.
- Diffuser: UV - stabilised, PRO-LINE optic. Electrical connection via push wire terminal block..
- Complete with 3000K or 4000K LED.

## MODELS

| CODE       | MODEL                  | POWER | DIMENSION | KELVIN      | HOUSING COLOR |
|------------|------------------------|-------|-----------|-------------|---------------|
| 6006000102 | TAMNA6_10W_G_LED_800   | 10W   | 600x80mm  | 3000K/4000K | Grey          |
| 6006000103 | TAMNA6_16W_G_LED_1280  | 16W   | 600x80mm  | 3000K/4000K | Grey          |
| 6006000104 | TAMNA12_12W_G_LED_960  | 12W   | 1200x80mm | 3000K/4000K | Grey          |
| 6006000105 | TAMNA12_24W_G_LED_1920 | 24W   | 1200x80mm | 3000K/4000K | Grey          |
| 6006000106 | TAMNA12_35W_G_LED_2800 | 35W   | 1200x80mm | 3000K/4000K | Grey          |
| 6006000107 | TAMNA16_15W_G_LED_1200 | 15W   | 1600x80mm | 3000K/4000K | Grey          |
| 6006000108 | TAMNA16_30W_G_LED_2400 | 30W   | 1600x80mm | 3000K/4000K | Grey          |
| 6006000109 | TAMNA16_45W_G_LED_3600 | 45W   | 1600x80mm | 3000K/4000K | Grey          |
| 6006000110 | TAMNA20_20W_G_LED_1600 | 20W   | 2000x80mm | 3000K/4000K | Grey          |
| 6006000111 | TAMNA20_40W_G_LED_3200 | 40W   | 2000x80mm | 3000K/4000K | Grey          |
| 6006000112 | TAMNA20_60W_G_LED_4800 | 60W   | 2000x80mm | 3000K/4000K | Grey          |
| 6006000113 | TAMNA24_22W_G_LED_1760 | 22W   | 2400x80mm | 3000K/4000K | Grey          |
| 6006000114 | TAMNA24_45W_G_LED_3600 | 45W   | 2400x80mm | 3000K/4000K | Grey          |



SENSOR



IP54

IK08

CRI $\geq$ 903000K  
4000K

50000 h



WARRANTY

SAMSUNG  
LED CHIPSMADE  
IN LTU

## SPECIFICATIONS

- A surface mounting LED linear luminaire for outdoor and indoor using, with a slim 1,5mm profile and microwave sensor.
- Electronic, fixed output gear.
- Body: sheet steel white.
- Diffuser: UV - stabilised, PRO-LINE optic. Electrical connection via push wire terminal block.
- Complete with 3000K or 4000K LED.
- Luminaire warranty 5 years/sensor warranty 1 year.

## MODELS

| CODE       | MODEL                       | POWER | DIMENSION | KELVIN      | HOUSING COLOR |
|------------|-----------------------------|-------|-----------|-------------|---------------|
| 6006700076 | TAMNA6_10W_W_LED_800_SENS   | 10W   | 600x80mm  | 3000K/4000K | White         |
| 6006700077 | TAMNA6_16W_W_LED_1280_SENS  | 16W   | 600x80mm  | 3000K/4000K | White         |
| 6006700078 | TAMNA12_12W_W_LED_960_SENS  | 12W   | 1200x80mm | 3000K/4000K | White         |
| 6006700079 | TAMNA12_24W_W_LED_1920_SENS | 24W   | 1200x80mm | 3000K/4000K | White         |
| 6006700080 | TAMNA12_35W_W_LED_2800_SENS | 35W   | 1200x80mm | 3000K/4000K | White         |
| 6006700081 | TAMNA16_15W_W_LED_1200_SENS | 15W   | 1600x80mm | 3000K/4000K | White         |
| 6006700082 | TAMNA16_30W_W_LED_2400_SENS | 30W   | 1600x80mm | 3000K/4000K | White         |
| 6006700083 | TAMNA16_45W_W_LED_3600_SENS | 45W   | 1600x80mm | 3000K/4000K | White         |
| 6006700084 | TAMNA20_20W_W_LED_1600_SENS | 20W   | 2000x80mm | 3000K/4000K | White         |
| 6006700085 | TAMNA20_40W_W_LED_3200_SENS | 40W   | 2000x80mm | 3000K/4000K | White         |
| 6006700086 | TAMNA20_60W_W_LED_4800_SENS | 60W   | 2000x80mm | 3000K/4000K | White         |
| 6006700087 | TAMNA24_22W_W_LED_1760_SENS | 22W   | 2400x80mm | 3000K/4000K | White         |
| 6006700088 | TAMNA24_45W_W_LED_3600_SENS | 45W   | 2400x80mm | 3000K/4000K | White         |



SENSOR



IP54

IK08

CRI $\geq$ 903000K  
4000K

50000 h



WARRANTY

SAMSUNG  
LED CHIPSMADE  
IN LTU

## SPECIFICATIONS

- A surface mounting LED linear luminaire for outdoor and indoor using, with a slim 1,5mm profile and microwave sensor.
- Electronic, fixed output gear.
- Body: sheet steel black.
- Diffuser: UV - stabilised, PRO-LINE optic. Electrical connection via push wire terminal block..
- Complete with 3000K or 4000K LED.
- Luminaire warranty 5 years/sensor warranty 1 year.

## MODELS

| CODE       | MODEL                       | POWER | DIMENSION | KELVIN      | HOUSING COLOR |
|------------|-----------------------------|-------|-----------|-------------|---------------|
| 6006700089 | TAMNA6_10W_B_LED_800_SENS   | 10W   | 600x80mm  | 3000K/4000K | Black         |
| 6006700090 | TAMNA6_16W_B_LED_1280_SENS  | 16W   | 600x80mm  | 3000K/4000K | Black         |
| 6006700091 | TAMNA12_12W_B_LED_960_SENS  | 12W   | 1200x80mm | 3000K/4000K | Black         |
| 6006700092 | TAMNA12_24W_B_LED_1920_SENS | 24W   | 1200x80mm | 3000K/4000K | Black         |
| 6006700093 | TAMNA12_35W_B_LED_2800_SENS | 35W   | 1200x80mm | 3000K/4000K | Black         |
| 6006700094 | TAMNA16_15W_B_LED_1200_SENS | 15W   | 1600x80mm | 3000K/4000K | Black         |
| 6006700095 | TAMNA16_30W_B_LED_2400_SENS | 30W   | 1600x80mm | 3000K/4000K | Black         |
| 6006700096 | TAMNA16_45W_B_LED_3600_SENS | 45W   | 1600x80mm | 3000K/4000K | Black         |
| 6006700097 | TAMNA20_20W_B_LED_1600_SENS | 20W   | 2000x80mm | 3000K/4000K | Black         |
| 6006700098 | TAMNA20_40W_B_LED_3200_SENS | 40W   | 2000x80mm | 3000K/4000K | Black         |
| 6006700099 | TAMNA20_60W_B_LED_4800_SENS | 60W   | 2000x80mm | 3000K/4000K | Black         |
| 6006700100 | TAMNA24_22W_B_LED_1760_SENS | 22W   | 2400x80mm | 3000K/4000K | Black         |
| 6006700101 | TAMNA24_45W_B_LED_3600_SENS | 45W   | 2400x80mm | 3000K/4000K | Black         |



## SPECIFICATIONS

- A surface mounting LED linear luminaire for outdoor and indoor using, with a slim 1,5mm profile and microwave sensor.
- Electronic, fixed output gear.
- Body: sheet steel grey.
- Diffuser: UV - stabilised, PRO-LINE optic. Electrical connection via push wire terminal block..
- Complete with 3000K or 4000K LED.
- Luminaire warranty 5 years/sensor warranty 1 year.

## MODELS

| CODE       | MODEL                       | POWER | DIMENSION | KELVIN      | HOUSING COLOR |
|------------|-----------------------------|-------|-----------|-------------|---------------|
| 6006700102 | TAMNA6_10W_G_LED_800_SENS   | 10W   | 600x80mm  | 3000K/4000K | Grey          |
| 6006700103 | TAMNA6_16W_G_LED_1280_SENS  | 16W   | 600x80mm  | 3000K/4000K | Grey          |
| 6006700104 | TAMNA12_12W_G_LED_960_SENS  | 12W   | 1200x80mm | 3000K/4000K | Grey          |
| 6006700105 | TAMNA12_24W_G_LED_1920_SENS | 24W   | 1200x80mm | 3000K/4000K | Grey          |
| 6006700106 | TAMNA12_35W_G_LED_2800_SENS | 35W   | 1200x80mm | 3000K/4000K | Grey          |
| 6006700107 | TAMNA16_15W_G_LED_1200_SENS | 15W   | 1600x80mm | 3000K/4000K | Grey          |
| 6006700108 | TAMNA16_30W_G_LED_2400_SENS | 30W   | 1600x80mm | 3000K/4000K | Grey          |
| 6006700109 | TAMNA16_45W_G_LED_3600_SENS | 45W   | 1600x80mm | 3000K/4000K | Grey          |
| 6006700110 | TAMNA20_20W_G_LED_1600_SENS | 20W   | 2000x80mm | 3000K/4000K | Grey          |
| 6006700111 | TAMNA20_40W_G_LED_3200_SENS | 40W   | 2000x80mm | 3000K/4000K | Grey          |
| 6006700112 | TAMNA20_60W_G_LED_4800_SENS | 60W   | 2000x80mm | 3000K/4000K | Grey          |
| 6006700113 | TAMNA24_22W_G_LED_1760_SENS | 22W   | 2400x80mm | 3000K/4000K | Grey          |
| 6006700114 | TAMNA24_45W_G_LED_3600_SENS | 45W   | 2400x80mm | 3000K/4000K | Grey          |



MADE  
IN LTU

DIM

IP54

IK08

CRI≥90

3000K  
4000K

50000 h

SAMSUNG  
LED CHIPS

5  
WARRANTY

## SPECIFICATIONS

- A surface mounting LED linear luminaire for outdoor and indoor using, with a slim 1,5mm profile.
- Light intensity control (dimming: TRIAC, 0-10V).
- Body: sheet steel white.
- Diffuser: UV - stabilised, PRO-LINE optic. Electrical connection via push wire terminal block..
- Complete with 3000K or 4000K LED.

## MODELS

| CODE       | MODEL                      | POWER | DIMENSION | KELVIN      | HOUSING COLOR |
|------------|----------------------------|-------|-----------|-------------|---------------|
| 6006300076 | TAMNA6_10W_W_LED_800_DIM   | 10W   | 600x80mm  | 3000K/4000K | White         |
| 6006300077 | TAMNA6_16W_W_LED_1280_DIM  | 16W   | 600x80mm  | 3000K/4000K | White         |
| 6006300078 | TAMNA12_12W_W_LED_960_DIM  | 12W   | 1200x80mm | 3000K/4000K | White         |
| 6006300079 | TAMNA12_24W_W_LED_1920_DIM | 24W   | 1200x80mm | 3000K/4000K | White         |
| 6006300080 | TAMNA12_35W_W_LED_2800_DIM | 35W   | 1200x80mm | 3000K/4000K | White         |
| 6006300081 | TAMNA16_15W_W_LED_1200_DIM | 15W   | 1600x80mm | 3000K/4000K | White         |
| 6006300082 | TAMNA16_30W_W_LED_2400_DIM | 30W   | 1600x80mm | 3000K/4000K | White         |
| 6006300083 | TAMNA16_45W_W_LED_3600_DIM | 45W   | 1600x80mm | 3000K/4000K | White         |
| 6006300084 | TAMNA20_20W_W_LED_1600_DIM | 20W   | 2000x80mm | 3000K/4000K | White         |
| 6006300085 | TAMNA20_40W_W_LED_3200_DIM | 40W   | 2000x80mm | 3000K/4000K | White         |
| 6006300087 | TAMNA24_22W_W_LED_1760_DIM | 22W   | 2400x80mm | 3000K/4000K | White         |
| 6006300088 | TAMNA24_45W_W_LED_3600_DIM | 45W   | 2400x80mm | 3000K/4000K | White         |

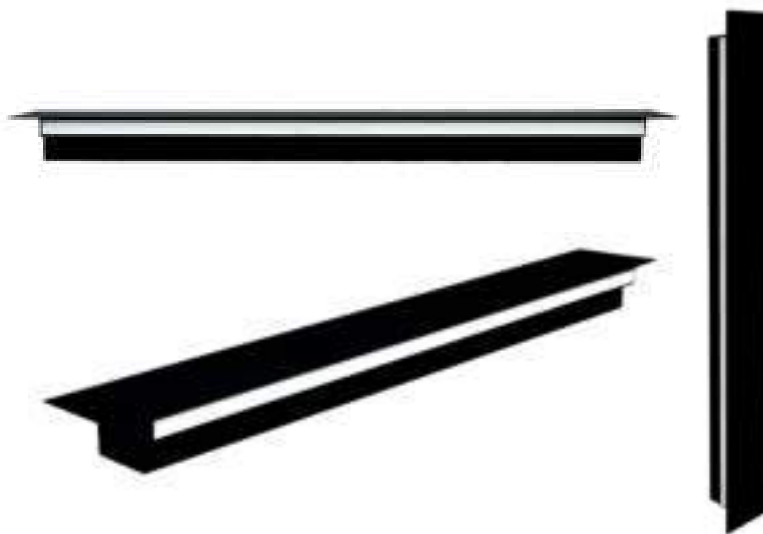

MADE IN LTU

DIM

IP54

IK08

CRI≥90

3000K  
4000K

50000 h

SAMSUNG  
LED CHIPS

5  
WARRANTY

## SPECIFICATIONS

- A surface mounting LED linear luminaire for outdoor and indoor using, with a slim 1,5mm profile.
- Light intensity control (dimming: TRIAC, 0-10V).
- Body: sheet steel black.
- Diffuser: UV - stabilised, PRO-LINE optic. Electrical connection via push wire terminal block..
- Complete with 3000K or 4000K LED.

## MODELS

| CODE       | MODEL                      | POWER | DIMENSION | KELVIN      | HOUSING COLOR |
|------------|----------------------------|-------|-----------|-------------|---------------|
| 6006300089 | TAMNA6_10W_B_LED_800_DIM   | 10W   | 600x80mm  | 3000K/4000K | Black         |
| 6006300090 | TAMNA6_16W_B_LED_1280_DIM  | 16W   | 600x80mm  | 3000K/4000K | Black         |
| 6006300091 | TAMNA12_12W_B_LED_960_DIM  | 12W   | 1200x80mm | 3000K/4000K | Black         |
| 6006300092 | TAMNA12_24W_B_LED_1920_DIM | 24W   | 1200x80mm | 3000K/4000K | Black         |
| 6006300093 | TAMNA12_35W_B_LED_2800_DIM | 35W   | 1200x80mm | 3000K/4000K | Black         |
| 6006300094 | TAMNA16_15W_B_LED_1200_DIM | 15W   | 1600x80mm | 3000K/4000K | Black         |
| 6006300095 | TAMNA16_30W_B_LED_2400_DIM | 30W   | 1600x80mm | 3000K/4000K | Black         |
| 6006300096 | TAMNA16_45W_B_LED_3600_DIM | 45W   | 1600x80mm | 3000K/4000K | Black         |
| 6006300097 | TAMNA20_20W_B_LED_1600_DIM | 20W   | 2000x80mm | 3000K/4000K | Black         |
| 6006300098 | TAMNA20_40W_B_LED_3200_DIM | 40W   | 2000x80mm | 3000K/4000K | Black         |
| 6006300100 | TAMNA24_22W_B_LED_1760_DIM | 22W   | 2400x80mm | 3000K/4000K | Black         |
| 6006300101 | TAMNA24_45W_B_LED_3600_DIM | 45W   | 2400x80mm | 3000K/4000K | Black         |



## SPECIFICATIONS

- A surface mounting LED linear luminaire for outdoor and indoor using, with a slim 1,5mm profile.
- Light intensity control (dimming: TRIAC, 0-10V).
- Body: sheet steel grey.
- Diffuser: UV - stabilised, PRO-LINE optic. Electrical connection via push wire terminal block..
- Complete with 3000K or 4000K LED.

## MODELS

| CODE       | MODEL                      | POWER | DIMENSION | KELVIN      | HOUSING COLOR |
|------------|----------------------------|-------|-----------|-------------|---------------|
| 6006300102 | TAMNA6_10W_G_LED_800_DIM   | 10W   | 600x80mm  | 3000K/4000K | Grey          |
| 6006300103 | TAMNA6_16W_G_LED_1280_DIM  | 16W   | 600x80mm  | 3000K/4000K | Grey          |
| 6006300104 | TAMNA12_12W_G_LED_960_DIM  | 12W   | 1200x80mm | 3000K/4000K | Grey          |
| 6006300105 | TAMNA12_24W_G_LED_1920_DIM | 24W   | 1200x80mm | 3000K/4000K | Grey          |
| 6006300106 | TAMNA12_35W_G_LED_2800_DIM | 35W   | 1200x80mm | 3000K/4000K | Grey          |
| 6006300107 | TAMNA16_15W_G_LED_1200_DIM | 15W   | 1600x80mm | 3000K/4000K | Grey          |
| 6006300108 | TAMNA16_30W_G_LED_2400_DIM | 30W   | 1600x80mm | 3000K/4000K | Grey          |
| 6006300109 | TAMNA16_45W_G_LED_3600_DIM | 45W   | 1600x80mm | 3000K/4000K | Grey          |
| 6006300110 | TAMNA20_20W_G_LED_1600_DIM | 20W   | 2000x80mm | 3000K/4000K | Grey          |
| 6006300111 | TAMNA20_40W_G_LED_3200_DIM | 40W   | 2000x80mm | 3000K/4000K | Grey          |
| 6006300113 | TAMNA24_22W_G_LED_1760_DIM | 22W   | 2400x80mm | 3000K/4000K | Grey          |
| 6006300114 | TAMNA24_45W_G_LED_3600_DIM | 45W   | 2400x80mm | 3000K/4000K | Grey          |

A surface mounting LED linear luminaire combined with charred wood (conifer) for outdoor and indoor using, with a slim 1,5mm profile.

After charring, the wood surface is wire-brushed, the coarse charred layer is brushed off and covered with the oil (For outdoor surfaces).

Because of these processes wood surface become soft silky, the burnt grooves are subtle shades of dark brown.

Covering the charred timber with oil reveals its structure and natural beauty.

Colored oils can give wood different shades.

Charring technology protects timber from humidity, UV rays, Mold, Parasites, Fire (the wood becomes more fire-resistant).

Electronic, fixed output gear.

IP67, IK08. Body: sheet steel.

Diffuser; UV-stabilised, PRO\_LINE optic.

Electrical connection via push wire terminal blocks.

Complete with 3000K or 4000K LED

#### **Charred wood maintenance**

Proper maintenance of charred wood allow to last for timber at least 50 years.

To preserve the color and properties of charred wood we recommend renew the oil (for outdoor surfaces) layer every 4-5 years.





LED INDOOR  
LIGHT



TOPE+  
LIGHTING



LED OUTDOOR  
LIGHT





## SPECIFICATIONS

- A surface mounting LED linear luminaire for outdoor and indoor using, with burned wood profile.
- Electronic, fixed output gear.
- Body: sheet steel white.
- Diffuser: UV - stabilised, PRO-LINE optic. Electrical connection via push wire terminal block..
- Complete with 3000K or 4000K LED.

## MODELS

| CODE       | MODEL                   | POWER | DIMENSION | KELVIN      | HOUSING COLOR |
|------------|-------------------------|-------|-----------|-------------|---------------|
| 6006000115 | TAMNA6_10W_WW_LED_800   | 10W   | 600x80mm  | 3000K/4000K | White         |
| 6006000116 | TAMNA6_16W_WW_LED_1280  | 16W   | 600x80mm  | 3000K/4000K | White         |
| 6006000117 | TAMNA12_12W_WW_LED_960  | 12W   | 1200x80mm | 3000K/4000K | White         |
| 6006000118 | TAMNA12_24W_WW_LED_1920 | 24W   | 1200x80mm | 3000K/4000K | White         |
| 6006000119 | TAMNA12_35W_WW_LED_2800 | 35W   | 1200x80mm | 3000K/4000K | White         |
| 6006000120 | TAMNA16_15W_WW_LED_1200 | 15W   | 1600x80mm | 3000K/4000K | White         |
| 6006000121 | TAMNA16_30W_WW_LED_2400 | 30W   | 1600x80mm | 3000K/4000K | White         |
| 6006000122 | TAMNA16_45W_WW_LED_3600 | 45W   | 1600x80mm | 3000K/4000K | White         |
| 6006000123 | TAMNA20_20W_WW_LED_1600 | 20W   | 2000x80mm | 3000K/4000K | White         |
| 6006000124 | TAMNA20_40W_WW_LED_3200 | 40W   | 2000x80mm | 3000K/4000K | White         |
| 6006000125 | TAMNA20_60W_WW_LED_4800 | 60W   | 2000x80mm | 3000K/4000K | White         |
| 6006000126 | TAMNA24_22W_WW_LED_1760 | 22W   | 2400x80mm | 3000K/4000K | White         |
| 6006000127 | TAMNA24_45W_WW_LED_3600 | 45W   | 2400x80mm | 3000K/4000K | White         |



MADE IN LTU    IP54    IK08    CRI≥90    3000K / 4000K    50000 h    5 WARRANTY    SAMSUNG LED CHIPS    MW POWER SUPPLY

**SPECIFICATIONS**

- A surface mounting LED linear luminaire for outdoor and indoor using, with burned wood profile.
- Electronic, fixed output gear.
- Body: sheet steel brown.
- Diffuser: UV - stabilised, PRO-LINE optic. Electrical connection via push wire terminal block..
- Complete with 3000K or 4000K LED.

**MODELS**

| CODE       | MODEL                   | POWER | DIMENSION | KELVIN      | HOUSING COLOR |
|------------|-------------------------|-------|-----------|-------------|---------------|
| 6006000128 | TAMNA6_10W_WB_LED_800   | 10W   | 600x80mm  | 3000K/4000K | Brown         |
| 6006000129 | TAMNA6_16W_WB_LED_1280  | 16W   | 600x80mm  | 3000K/4000K | Brown         |
| 6006000130 | TAMNA12_12W_WB_LED_960  | 12W   | 1200x80mm | 3000K/4000K | Brown         |
| 6006000131 | TAMNA12_24W_WB_LED_1920 | 24W   | 1200x80mm | 3000K/4000K | Brown         |
| 6006000132 | TAMNA12_35W_WB_LED_2800 | 35W   | 1200x80mm | 3000K/4000K | Brown         |
| 6006000133 | TAMNA16_15W_WB_LED_1200 | 15W   | 1600x80mm | 3000K/4000K | Brown         |
| 6006000134 | TAMNA16_30W_WB_LED_2400 | 30W   | 1600x80mm | 3000K/4000K | Brown         |
| 6006000135 | TAMNA16_45W_WB_LED_3600 | 45W   | 1600x80mm | 3000K/4000K | Brown         |
| 6006000136 | TAMNA20_20W_WB_LED_1600 | 20W   | 2000x80mm | 3000K/4000K | Brown         |
| 6006000137 | TAMNA20_40W_WB_LED_3200 | 40W   | 2000x80mm | 3000K/4000K | Brown         |
| 6006000138 | TAMNA20_60W_WB_LED_4800 | 60W   | 2000x80mm | 3000K/4000K | Brown         |
| 6006000139 | TAMNA24_22W_WB_LED_1760 | 22W   | 2400x80mm | 3000K/4000K | Brown         |
| 6006000140 | TAMNA24_45W_WB_LED_3600 | 45W   | 2400x80mm | 3000K/4000K | Brown         |



MADE  
IN LTU

  
IP54

IK08

CRI≥90

3000K  
4000K

  
50000 h

  
WARRANTY

SAMSUNG  
LED CHIPS

  
POWER SUPPLY

## SPECIFICATIONS

- A surface mounting LED linear luminaire for outdoor and indoor using, with burned wood profile.
- Electronic, fixed output gear.
- Body: sheet steel antracite.
- Diffuser: UV - stabilised, PRO-LINE optic. Electrical connection via push wire terminal block..
- Complete with 3000K or 4000K LED.

## MODELS

| CODE       | MODEL                   | POWER | DIMENSION | KELVIN      | HOUSING COLOR |
|------------|-------------------------|-------|-----------|-------------|---------------|
| 6006000141 | TAMNA6_10W_WA_LED_800   | 10W   | 600x80mm  | 3000K/4000K | Antracite     |
| 6006000142 | TAMNA6_16W_WA_LED_1280  | 16W   | 600x80mm  | 3000K/4000K | Antracite     |
| 6006000143 | TAMNA12_12W_WA_LED_960  | 12W   | 1200x80mm | 3000K/4000K | Antracite     |
| 6006000144 | TAMNA12_24W_WA_LED_1920 | 24W   | 1200x80mm | 3000K/4000K | Antracite     |
| 6006000145 | TAMNA12_35W_WA_LED_2800 | 35W   | 1200x80mm | 3000K/4000K | Antracite     |
| 6006000146 | TAMNA16_15W_WA_LED_1200 | 15W   | 1600x80mm | 3000K/4000K | Antracite     |
| 6006000147 | TAMNA16_30W_WA_LED_2400 | 30W   | 1600x80mm | 3000K/4000K | Antracite     |
| 6006000148 | TAMNA16_45W_WA_LED_3600 | 45W   | 1600x80mm | 3000K/4000K | Antracite     |
| 6006000149 | TAMNA20_20W_WA_LED_1600 | 20W   | 2000x80mm | 3000K/4000K | Antracite     |
| 6006000150 | TAMNA20_40W_WA_LED_3200 | 40W   | 2000x80mm | 3000K/4000K | Antracite     |
| 6006000151 | TAMNA20_60W_WA_LED_4800 | 60W   | 2000x80mm | 3000K/4000K | Antracite     |
| 6006000152 | TAMNA24_22W_WA_LED_1760 | 22W   | 2400x80mm | 3000K/4000K | Antracite     |
| 6006000153 | TAMNA24_45W_WA_LED_3600 | 45W   | 2400x80mm | 3000K/4000K | Antracite     |

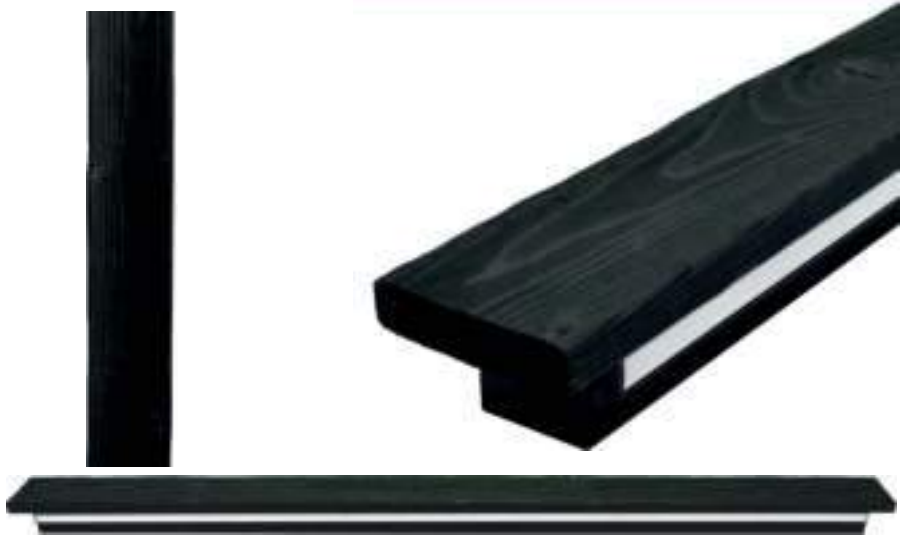

## SPECIFICATIONS

- A surface mounting LED linear luminaire for outdoor and indoor using, with burned wood profile.
- Electronic, fixed output gear.
- Body: sheet steel black.
- Diffuser: UV - stabilised, PRO-LINE optic. Electrical connection via push wire terminal block..
- Complete with 3000K or 4000K LED.

## MODELS

| CODE       | MODEL                    | POWER | DIMENSION | KELVIN      | HOUSING COLOR |
|------------|--------------------------|-------|-----------|-------------|---------------|
| 6006000154 | TAMNA6_10W_WBL_LED_800   | 10W   | 600x80mm  | 3000K/4000K | Black         |
| 6006000155 | TAMNA6_16W_WBL_LED_1280  | 16W   | 600x80mm  | 3000K/4000K | Black         |
| 6006000156 | TAMNA12_12W_WBL_LED_960  | 12W   | 1200x80mm | 3000K/4000K | Black         |
| 6006000157 | TAMNA12_24W_WBL_LED_1920 | 24W   | 1200x80mm | 3000K/4000K | Black         |
| 6006000158 | TAMNA12_35W_WBL_LED_2800 | 35W   | 1200x80mm | 3000K/4000K | Black         |
| 6006000159 | TAMNA16_15W_WBL_LED_1200 | 15W   | 1600x80mm | 3000K/4000K | Black         |
| 6006000160 | TAMNA16_30W_WBL_LED_2400 | 30W   | 1600x80mm | 3000K/4000K | Black         |
| 6006000161 | TAMNA16_45W_WBL_LED_3600 | 45W   | 1600x80mm | 3000K/4000K | Black         |
| 6006000162 | TAMNA20_20W_WBL_LED_1600 | 20W   | 2000x80mm | 3000K/4000K | Black         |
| 6006000163 | TAMNA20_40W_WBL_LED_3200 | 40W   | 2000x80mm | 3000K/4000K | Black         |
| 6006000164 | TAMNA20_60W_WBL_LED_4800 | 60W   | 2000x80mm | 3000K/4000K | Black         |
| 6006000165 | TAMNA24_22W_WBL_LED_1760 | 22W   | 2400x80mm | 3000K/4000K | Black         |
| 6006000166 | TAMNA24_45W_WBL_LED_3600 | 45W   | 2400x80mm | 3000K/4000K | Black         |



## SPECIFICATIONS

- A surface mounting LED linear luminaire for outdoor and indoor using, with burned wood profile.
- Light intensity control (dimming: TRIAC, 0-10V).
- Body: sheet steel white.
- Diffuser: UV - stabilised, PRO-LINE optic. Electrical connection via push wire terminal block..
- Complete with 3000K or 4000K LED.

## MODELS

| CODE       | MODEL                       | POWER | DIMENSION | KELVIN      | HOUSING COLOR |
|------------|-----------------------------|-------|-----------|-------------|---------------|
| 6006300115 | TAMNA6_10W_WW_LED_800_DIM   | 10W   | 600x80mm  | 3000K/4000K | White         |
| 6006300116 | TAMNA6_16W_WW_LED_1280_DIM  | 16W   | 600x80mm  | 3000K/4000K | White         |
| 6006300117 | TAMNA12_12W_WW_LED_960_DIM  | 12W   | 1200x80mm | 3000K/4000K | White         |
| 6006300118 | TAMNA12_24W_WW_LED_1920_DIM | 24W   | 1200x80mm | 3000K/4000K | White         |
| 6006300119 | TAMNA12_35W_WW_LED_2800_DIM | 35W   | 1200x80mm | 3000K/4000K | White         |
| 6006300120 | TAMNA16_15W_WW_LED_1200_DIM | 15W   | 1600x80mm | 3000K/4000K | White         |
| 6006300121 | TAMNA16_30W_WW_LED_2400_DIM | 30W   | 1600x80mm | 3000K/4000K | White         |
| 6006300122 | TAMNA16_45W_WW_LED_3600_DIM | 45W   | 1600x80mm | 3000K/4000K | White         |
| 6006300123 | TAMNA20_20W_WW_LED_1600_DIM | 20W   | 2000x80mm | 3000K/4000K | White         |
| 6006300124 | TAMNA20_40W_WW_LED_3200_DIM | 40W   | 2000x80mm | 3000K/4000K | White         |
| 6006300126 | TAMNA24_22W_WW_LED_1760_DIM | 22W   | 2400x80mm | 3000K/4000K | White         |
| 6006300127 | TAMNA24_45W_WW_LED_3600_DIM | 45W   | 2400x80mm | 3000K/4000K | White         |



**SPECIFICATIONS**

- A surface mounting LED linear luminaire for outdoor and indoor using, with burned wood profile.
- Light intensity control (dimming: TRIAC, 0-10V).
- Body: sheet steel brown.
- Diffuser: UV - stabilised, PRO-LINE optic. Electrical connection via push wire terminal block..
- Complete with 3000K or 4000K LED.

**MODELS**

| CODE       | MODEL                       | POWER | DIMENSION | KELVIN      | HOUSING COLOR |
|------------|-----------------------------|-------|-----------|-------------|---------------|
| 6006300128 | TAMNA6_10W_WB_LED_800_DIM   | 10W   | 600x80mm  | 3000K/4000K | Brown         |
| 6006300129 | TAMNA6_16W_WB_LED_1280_DIM  | 16W   | 600x80mm  | 3000K/4000K | Brown         |
| 6006300130 | TAMNA12_12W_WB_LED_960_DIM  | 12W   | 1200x80mm | 3000K/4000K | Brown         |
| 6006300131 | TAMNA12_24W_WB_LED_1920_DIM | 24W   | 1200x80mm | 3000K/4000K | Brown         |
| 6006300132 | TAMNA12_35W_WB_LED_2800_DIM | 35W   | 1200x80mm | 3000K/4000K | Brown         |
| 6006300133 | TAMNA16_15W_WB_LED_1200_DIM | 15W   | 1600x80mm | 3000K/4000K | Brown         |
| 6006300134 | TAMNA16_30W_WB_LED_2400_DIM | 30W   | 1600x80mm | 3000K/4000K | Brown         |
| 6006300135 | TAMNA16_45W_WB_LED_3600_DIM | 45W   | 1600x80mm | 3000K/4000K | Brown         |
| 6006300136 | TAMNA20_20W_WB_LED_1600_DIM | 20W   | 2000x80mm | 3000K/4000K | Brown         |
| 6006300137 | TAMNA20_40W_WB_LED_3200_DIM | 40W   | 2000x80mm | 3000K/4000K | Brown         |
| 6006300139 | TAMNA24_22W_WB_LED_1760_DIM | 22W   | 2400x80mm | 3000K/4000K | Brown         |
| 6006300140 | TAMNA24_45W_WB_LED_3600_DIM | 45W   | 2400x80mm | 3000K/4000K | Brown         |





## SPECIFICATIONS

- A surface mounting LED linear luminaire for outdoor and indoor using, with burned wood profile.
- Light intensity control (dimming: TRIAC, 0-10V).
- Body: sheet steel antracite.
- Diffuser: UV - stabilised, PRO-LINE optic. Electrical connection via push wire terminal block..
- Complete with 3000K or 4000K LED.

## MODELS

| CODE       | MODEL                       | POWER | DIMENSION | KELVIN      | HOUSING COLOR |
|------------|-----------------------------|-------|-----------|-------------|---------------|
| 6006300141 | TAMNA6_10W_WA_LED_800_DIM   | 10W   | 600x80mm  | 3000K/4000K | Antracite     |
| 6006300142 | TAMNA6_16W_WA_LED_1280_DIM  | 16W   | 600x80mm  | 3000K/4000K | Antracite     |
| 6006300143 | TAMNA12_12W_WA_LED_960_DIM  | 12W   | 1200x80mm | 3000K/4000K | Antracite     |
| 6006300144 | TAMNA12_24W_WA_LED_1920_DIM | 24W   | 1200x80mm | 3000K/4000K | Antracite     |
| 6006300145 | TAMNA12_35W_WA_LED_2800_DIM | 35W   | 1200x80mm | 3000K/4000K | Antracite     |
| 6006300146 | TAMNA16_15W_WA_LED_1200_DIM | 15W   | 1600x80mm | 3000K/4000K | Antracite     |
| 6006300147 | TAMNA16_30W_WA_LED_2400_DIM | 30W   | 1600x80mm | 3000K/4000K | Antracite     |
| 6006300148 | TAMNA16_45W_WA_LED_3600_DIM | 45W   | 1600x80mm | 3000K/4000K | Antracite     |
| 6006300149 | TAMNA20_20W_WA_LED_1600_DIM | 20W   | 2000x80mm | 3000K/4000K | Antracite     |
| 6006300150 | TAMNA20_40W_WA_LED_3200_DIM | 40W   | 2000x80mm | 3000K/4000K | Antracite     |
| 6006300152 | TAMNA24_22W_WA_LED_1760_DIM | 22W   | 2400x80mm | 3000K/4000K | Antracite     |
| 6006300153 | TAMNA24_45W_WA_LED_3600_DIM | 45W   | 2400x80mm | 3000K/4000K | Antracite     |



**SPECIFICATIONS**

- A surface mounting LED linear luminaire for outdoor and indoor using, with burned wood profile.
- Light intensity control (dimming: TRIAC, 0-10V).
- Body: sheet steel black.
- Diffuser: UV - stabilised, PRO-LINE optic. Electrical connection via push wire terminal block..
- Complete with 3000K or 4000K LED.

**MODELS**





| CODE       | MODEL                        | POWER | DIMENSION | KELVIN      | HOUSING COLOR |
|------------|------------------------------|-------|-----------|-------------|---------------|
| 6006300154 | TAMNA6_10W_WBL_LED_800_DIM   | 10W   | 600x80mm  | 3000K/4000K | Black         |
| 6006300155 | TAMNA6_16W_WBL_LED_1280_DIM  | 16W   | 600x80mm  | 3000K/4000K | Black         |
| 6006300156 | TAMNA12_12W_WBL_LED_960_DIM  | 12W   | 1200x80mm | 3000K/4000K | Black         |
| 6006300157 | TAMNA12_24W_WBL_LED_1920_DIM | 24W   | 1200x80mm | 3000K/4000K | Black         |
| 6006300158 | TAMNA12_35W_WBL_LED_2800_DIM | 35W   | 1200x80mm | 3000K/4000K | Black         |
| 6006300159 | TAMNA16_15W_WBL_LED_1200_DIM | 15W   | 1600x80mm | 3000K/4000K | Black         |
| 6006300160 | TAMNA16_30W_WBL_LED_2400_DIM | 30W   | 1600x80mm | 3000K/4000K | Black         |
| 6006300161 | TAMNA16_45W_WBL_LED_3600_DIM | 45W   | 1600x80mm | 3000K/4000K | Black         |
| 6006300162 | TAMNA20_20W_WBL_LED_1600_DIM | 20W   | 2000x80mm | 3000K/4000K | Black         |
| 6006300163 | TAMNA20_40W_WBL_LED_3200_DIM | 40W   | 2000x80mm | 3000K/4000K | Black         |
| 6006300165 | TAMNA24_22W_WBL_LED_1760_DIM | 22W   | 2400x80mm | 3000K/4000K | Black         |
| 6006300166 | TAMNA24_45W_WBL_LED_3600_DIM | 45W   | 2400x80mm | 3000K/4000K | Black         |



LED INDUSTRIAL  
LIGHT

**TOPE**   
**LIGHTING**



-   
**IP54**
- IK08**
- CRI≥80**
-   
**4000K**
-   
**50000 h**
-   
**WARRANTY**
-   
**30°/90°**

**SPECIFICATIONS**

- An IP54 two point suspension LED linear high bay luminaire with Wide beam optic.
- Electronic, fixed output control gear. IK08.
- Housing/Fins: die-cast Aluminum fins allow air flow cooling of luminaire and components.
- Lens/Diffuser: Polycarbonate (PC). Angle 80°/110°.
- Driver: SOSEN. Complete with 4000K LED.

**URAN\_30°/90°**

**MODELS**

| CODE         | MODEL                        | POWER | DIMENSION      | LUMEN    |
|--------------|------------------------------|-------|----------------|----------|
| 6009000007/9 | URAN150_100W_LED_15000_30/90 | 100W  | 570x150x55 mm  | 17000 lm |
| 6009000008/9 | URAN150_150W_LED_23000_30/90 | 150W  | 865x150x60 mm  | 25500 lm |
| 6009000009/9 | URAN150_200W_LED_30000_30/90 | 200W  | 1145x150x60 mm | 34000 lm |

**URAN\_30°/90°\_EMERGENCY**

- With emergency block (2h).

**MODELS**

| CODE         | MODEL                           | POWER | DIMENSION      | LUMEN    | EM. LUMEN  | EM. WORKING TIME |
|--------------|---------------------------------|-------|----------------|----------|------------|------------------|
| 6009200007/9 | URAN150_100W_LED_15000_30/90_EM | 100W  | 570x150x55 mm  | 17000 lm | max 680 lm | 2h               |
| 6009200008/9 | URAN150_150W_LED_23000_30/90_EM | 150W  | 865x150x60 mm  | 25500 lm | max 680 lm | 2h               |
| 6009200009/9 | URAN150_200W_LED_30000_30/90_EM | 200W  | 1145x150x60 mm | 34000 lm | max 680 lm | 2h               |

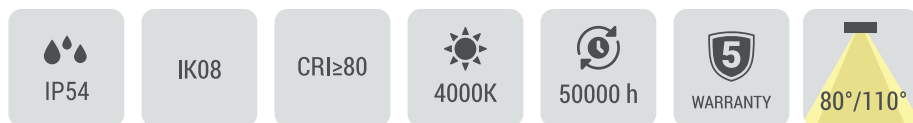

### SPECIFICATIONS

- An IP54 two point suspension LED linear high bay luminaire with Wide beam optic.
- Electronic, fixed output control gear. IK08.
- Housing/Fins: die-cast Aluminum fins allow air flow cooling of luminaire and components.
- Lens/Diffuser: Polycarbonate (PC). Angle 80°/110°.
- Driver: SOSEN. Complete with 4000K LED.

### MODELS

| CODE       | MODEL                         | POWER | DIMENSION      | LUMEN    |
|------------|-------------------------------|-------|----------------|----------|
| 6009000007 | URAN150_100W_LED_15000_80/110 | 100W  | 570x150x55 mm  | 17000 lm |
| 6009000008 | URAN150_150W_LED_23000_80/110 | 150W  | 865x150x60 mm  | 25500 lm |
| 6009000009 | URAN150_200W_LED_30000_80/110 | 200W  | 1145x150x60 mm | 34000 lm |

### URAN\_80°/110°\_EMERGENCY

- With emergency block (2h).

### MODELS

| CODE       | MODEL                            | POWER | DIMENSION      | LUMEN    | EM. LUMEN  | EM. WORKING TIME |
|------------|----------------------------------|-------|----------------|----------|------------|------------------|
| 6009200007 | URAN150_100W_LED_15000_80/110_EM | 100W  | 570x150x55 mm  | 17000 lm | max 680 lm | 2h               |
| 6009200008 | URAN150_150W_LED_23000_80/110_EM | 150W  | 865x150x60 mm  | 25500 lm | max 680 lm | 2h               |
| 6009200009 | URAN150_200W_LED_30000_80/110_EM | 200W  | 1145x150x60 mm | 34000 lm | max 680 lm | 2h               |



|   |  |   |   |  |   |   |
|---|--|---|---|--|---|---|
| <br>IP65 | <br>4000K | <br>IK08 | <br>CRI≥80 | <br>50000 h | <br>WARRANTY | <br>90° |
|---|--|---|---|--|---|---|

### SPECIFICATIONS

- LED high bay luminaire for suspended installation, with lens optic for high mounting applications.
- Electronic, fixed output control gear. IP65 , IK08. Housing : die-cast aluminum.
- Lens/Diffuser: Polycarbonate (PC). Optics 90° . Equipped with quick fit electrical connection.
- Complete with 4000K LED. With SOSEN driver.
- With 0-10V dimmable option.

### MODELS

| CODE       | MODEL                 | POWER | DIMENSION  | LUMEN   |
|------------|-----------------------|-------|------------|---------|
| 6009000010 | UNA180_100W_LED_18000 | 100W  | Ø248x158mm | 18000lm |
| 6009000011 | UNA180_150W_LED_27000 | 150W  | Ø308x168mm | 27000lm |
| 6009000012 | UNA180_200W_LED_36000 | 200W  | Ø360x174mm | 36000lm |

### DALI

| CODE       | MODEL                   | POWER | DIMENSION  | LUMEN   |
|------------|-------------------------|-------|------------|---------|
| 6009400010 | UNA180_100W_LED_18000_D | 100W  | Ø248x158mm | 18000lm |
| 6009400011 | UNA180_150W_LED_27000_D | 150W  | Ø308x168mm | 27000lm |
| 6009400012 | UNA180_200W_LED_36000_D | 200W  | Ø360x174mm | 36000lm |



### SPECIFICATIONS

- LED high bay luminaire for suspended installation, with lens optic for high mounting applications.
- Electronic, fixed output control gear. IP65 , IK08. Housing : die-cast aluminum.
- Lens/Diffuser: Polycarbonate (PC). Optics 90° . Equipped with quick fit electrical connection.
- Complete with 4000K LED. With SOSEN driver.
- With 0-10V dimmable option.

### MODELS

| CODE       | MODEL                 | POWER | DIMENSION   | LUMEN    |
|------------|-----------------------|-------|-------------|----------|
| 6009000004 | UBE130_100W_LED_15000 | 100W  | Ø258x139 mm | 13000 lm |
| 6009000005 | UBE130_150W_LED_23000 | 150W  | Ø299x139 mm | 19500 lm |
| 6009000006 | UBE130_200W_LED_30000 | 200W  | Ø347x142 mm | 26000 lm |



### UBE\_EMERGENCY

- With emergency block (2h).



### MODELS

| CODE       | MODEL                    | POWER | DIMENSION   | LUMEN    | EM. LUMEN  | EM. WORKING TIME |
|------------|--------------------------|-------|-------------|----------|------------|------------------|
| 6009200004 | UBE130_100W_LED_15000_EM | 100W  | Ø258x139 mm | 13000 lm | max 520 lm | 2h               |
| 6009200005 | UBE130_150W_LED_23000_EM | 150W  | Ø299x139 mm | 19500 lm | max 520 lm | 2h               |
| 6009200006 | UBE130_200W_LED_30000_EM | 200W  | Ø347x142mm  | 26000 lm | max 520 lm | 2h               |

### DALI

| CODE       | MODEL                   | POWER | DIMENSION   | LUMEN    |
|------------|-------------------------|-------|-------------|----------|
| 6009400004 | UBE130_100W_LED_15000_D | 100W  | Ø258x139 mm | 13000 lm |
| 6009400005 | UBE130_150W_LED_23000_D | 150W  | Ø299x139 mm | 19500 lm |
| 6009400006 | UBE130_200W_LED_30000_D | 200W  | Ø347x142 mm | 26000 lm |

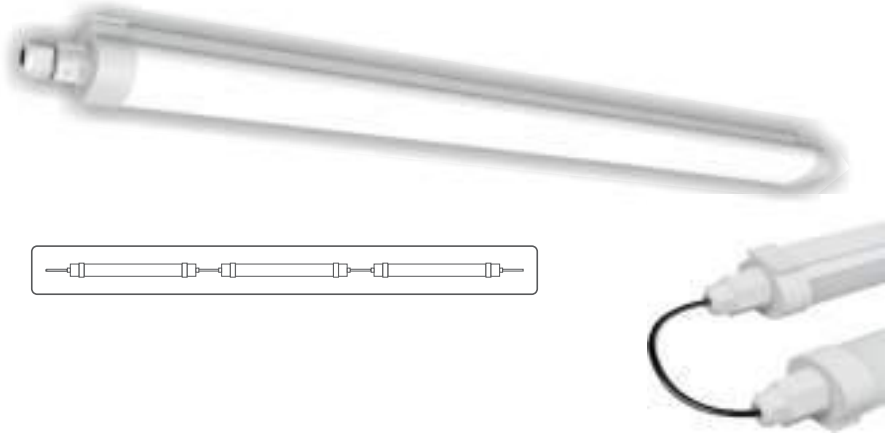

## SPECIFICATIONS

- IP65, IK08, dust and water resistant LED luminaire.
- Electronic, fixed output control gear. Class I electrical.
- Canopy: light grey Polycarbonate (PC). Diffuser: Polycarbonate (PC) with linear prisms.
- For surface or suspended mounting. Quick-fix brackets supplied for surface mounting.
- Supplied with quick connector.
- Complete with 4000K LED.

## MODELS

| CODE       | MODEL                | POWER | DIMENSION    | LUMEN   |
|------------|----------------------|-------|--------------|---------|
| 6007000025 | LION140_18W_LED_2520 | 18W   | 600x70x50mm  | 2520 lm |
| 6007000026 | LION140_36W_LED_5040 | 36W   | 1200x70x50mm | 5040 lm |
| 6007000027 | LION140_50W_LED_7000 | 50W   | 1500x70x50mm | 7000 lm |
| 6007000028 | LION140_70W_LED_9800 | 70W   | 1500x70x50mm | 9800 lm |

## LION\_EMERGENCY

| CODE       | MODEL                   | POWER | DIMENSION    | LUMEN   |
|------------|-------------------------|-------|--------------|---------|
| 6007200025 | LION140_18W_LED_2520_EM | 18W   | 600x70x50mm  | 2520 lm |
| 6007200026 | LION140_36W_LED_5040_EM | 36W   | 1200x70x50mm | 5040 lm |
| 6007200027 | LION140_50W_LED_7000_EM | 50W   | 1500x70x50mm | 7000 lm |





**SPECIFICATIONS**

- IP65, IK08, dust and water resistant LED luminaire.
- Electronic, fixed output control gear. Body: white Polycarbonate (PC). Diffuser: Polycarbonate (PC).
- End caps: reinforced polyamide (PA), secured with (PA) glands
- For surface, suspended, ceiling or wall (vertical or horizontal) mounting. Supplied with quick-fix brackets for surface mounting.
- Easy connection to the line with additional accessories\* (accessories are not included in the set).
- Complete with 3000K/ 4000K / 6000K LED. There is option to change CCT by dip switch.

**MODELS**

| CODE       | MODEL                    | POWER | DIMENSION     | LUMEN   | KELVIN |
|------------|--------------------------|-------|---------------|---------|--------|
| 6007000013 | NIDA140_18W_LED_CCT_2520 | 18W   | 680x60x60 mm  | 2520 lm | CCT    |
| 6007000014 | NIDA140_36W_LED_CCT_5040 | 36W   | 1240x60x60 mm | 5040 lm | CCT    |
| 6007000015 | NIDA140_50W_LED_CCT_7000 | 50W   | 1540x60x60 mm | 7000 lm | CCT    |

**NIDA**

- Complete with 4000K LED.



**MODELS**

| CODE       | MODEL                | POWER | DIMENSION     | LUMEN   | KELVIN |
|------------|----------------------|-------|---------------|---------|--------|
| 6007000016 | NIDA140_18W_LED_2520 | 18W   | 680x60x60 mm  | 2520 lm | 4000   |
| 6007000017 | NIDA140_36W_LED_5040 | 36W   | 1240x60x60 mm | 5040 lm | 4000   |
| 6007000018 | NIDA140_50W_LED_7000 | 50W   | 1540x60x60 mm | 7000 lm | 4000   |

**ACCESSORIES**



| CODE       | MODEL          | NAME                                 |
|------------|----------------|--------------------------------------|
| 6007800001 | NIDA_CONNECTOR | CONNECTOR FOR CONNECTION TO THE LINE |



160LM/W

RoHS



IP66

IK10

CRI≥80



4000K



70000 h



WARRANTY

PRODUCTION AND DELIVERY TIME - 3 MONTHS

## SPECIFICATIONS

- Dust and water resistant LED luminaire.
- Electronic, fixed output control gear.
- Class II electrical. Body: Aluminium.
- For surface mounting, ceiling or wall (vertical or horizontal), corner mounting.
- Supplied with Quick Fix Bracket.
- Complete with push wire terminals for wire up to 2,5mm<sup>2</sup>.

## MODELS

| CODE       | MODEL                       | POWER | DIMENSION      | LUMEN | KELVIN |
|------------|-----------------------------|-------|----------------|-------|--------|
| 6007000031 | NOSTRA160_20W_LED_4800      | 20W   | 600x122x102mm  | 4800  | 4000K  |
| 6007000032 | NOSTRA160_40W_LED_6400      | 40W   | 1200x122x102mm | 6400  | 4000K  |
| 6007000033 | NOSTRA160_60W_LED_9600      | 60W   | 1200x122x102mm | 9600  | 4000K  |
| 6007000034 | NOSTRA160_80W_LED_12800     | 80W   | 1200x122x102mm | 12800 | 4000K  |
| 6007000035 | NOSTRA160_15_80W_LED_12800  | 80W   | 1500x122x102mm | 12800 | 4000K  |
| 6007000036 | NOSTRA160_120W_LED_19200    | 120W  | 1200x122x102mm | 19200 | 4000K  |
| 6007000037 | NOSTRA160_15_120W_LED_19200 | 120W  | 1500x122x102mm | 19200 | 4000K  |
| 6007000038 | NOSTRA160_150W_LED_24000    | 150W  | 1500x122x102mm | 24000 | 4000K  |

## Accessories:

|            |  |
|------------|--|
| 6007900031 | Wall mounting bracket, angle adjustable. 2 pcs set |
|------------|--|



DIM

IP65

IK08

CRI≥80

4000K

50000 h

WARRANTY

## SPECIFICATIONS

- An IP65, IK08, dust and moisture resistant LED luminaire.
- Electronic, dimmable output control gear. Class II electrical.
- Body: white polycarbonat.
- Diffuser: opal polycarbonate.
- End caps: reinforced polyamide (PA), secured with (PA) glands.
- For surface mounting, ceiling or wall ( vertical or horizontal), corner mounting.
- Supplied with Quick Fix Bracket. Suitable for use in un-protected outdoor areas.
- Complete with push wire terminals for wire up to 2.5mm<sup>2</sup>.
- 1-10V Dimmable.
- 140lm/W, 4000K.

## MODELS

| CODE       | MODEL                 | POWER | DIMENSION | LUMEN   |
|------------|-----------------------|-------|-----------|---------|
| 6007100028 | NITRA140_20W_LED_2800 | 20W   | 659 mm    | 2800 lm |
| 6007100029 | NITRA140_40W_LED_5600 | 40W   | 1212 mm   | 5600 lm |
| 6007100030 | NITRA140_60W_LED_8400 | 60W   | 1502 mm   | 8400 lm |



## SPECIFICATIONS

- IP65, IK08, dust and water resistant LED luminaire.
- Electronic, fixed output control gear. Class I electrical.
- Canopy: light grey Polycarbonate (PC). Diffuser: Polycarbonate (PC) with linear prisms.
- For surface or suspended mounting. Quick-fix brackets supplied for surface mounting.
- Supplied with quick connector.
- Complete with 4000K LED.

## MODELS

| CODE       | MODEL                | POWER | DIMENSION    | LUMEN  |
|------------|----------------------|-------|--------------|--------|
| 6007000019 | NOLA100_30W_LED_3000 | 30W   | 630x80x45mm  | 3000lm |
| 6007000020 | NOLA100_36W_LED_3600 | 36W   | 1230x80x45mm | 3600lm |
| 6007000021 | NOLA100_60W_LED_6000 | 60W   | 1230x80x45mm | 6000lm |
| 6007000022 | NOLA100_70W_LED_7000 | 70W   | 1530x80x45mm | 7000lm |



## SPECIFICATIONS

- IP65, IK08, dust and water resistant LED luminaire.
- Electronic, fixed output control gear. Class I electrical.
- Canopy: light grey Polycarbonate (PC). Diffuser: Polycarbonate (PC) with linear prisms.
- For surface or suspended mounting. Quick-fix brackets supplied for surface mounting.
- Supplied with quick connector.
- Complete with 4000K LED.

## MODELS

| CODE       | MODEL                  | POWER | DIMENSION     | LUMEN   |
|------------|------------------------|-------|---------------|---------|
| 6007000023 | NAKA100_100W_LED_10000 | 100W  | 1265x80x80 mm | 10000lm |
| 6007000024 | NAKA100_120W_LED_12000 | 120W  | 1570x80x80 mm | 12000lm |



IP65
IK08
CRI≥80
4000K
30000 h
WARRANTY 2
120°

**SPECIFICATIONS**

- IP65, IK08, dust and water resistant LED luminaire.
- Electronic, fixed output control gear. Housing: white Polycarbonate (PC). Diffuser: Polycarbonate (PC).
- For surface or suspended mounting. Quick-fix brackets supplied for surface mounting.
- Complete with 4000K LED.

**MODELS**

| CODE       | MODEL                | POWER | DIMENSION     | LUMEN   |
|------------|----------------------|-------|---------------|---------|
| 6007000005 | LAOS100_18W_LED_1800 | 18W   | 685x43x30 mm  | 1443 lm |
| 6007000001 | LAOS100_36W_LED_3600 | 36W   | 1295x43x30 mm | 3455 lm |



- Mounting kits for conduit, chain suspension conduit, chain suspension and catenary suspension are available as accessories.
- With emergency block. Working time 2h.

**LAOS\_EMERGENCY**

Emergency icon
IP65
IK08
CRI≥80
4000K
WARRANTY 2
120°

**MODELS**

| CODE       | MODEL                  | POWER | DIMENSION     | LUMEN   | EM. LUMEN  | EM. WORKING TIME |
|------------|------------------------|-------|---------------|---------|------------|------------------|
| 6007200005 | LAOS100_18W_LED_1800EM | 18W   | 685x43x30 mm  | 1443 lm | max 320 lm | 2h               |
| 6007200001 | LAOS100_36W_LED_3600EM | 36W   | 1295x43x30 mm | 3455 lm | max 378 lm | 2h               |

A photograph of an industrial refinery or chemical plant at sunset. The sky is a mix of orange, yellow, and grey. In the center, a tall, slender distillation column stands out, featuring alternating dark and light horizontal bands. To its left and right are complex structures of pipes, ladders, and platforms, some of which are illuminated by bright lights, creating a strong contrast with the dimming natural light. The overall scene conveys a sense of industrial activity and safety.

LED EXPLOSION  
PROOF LIGHT

**TOPE** &  
**LIGHTING**

150LM/W

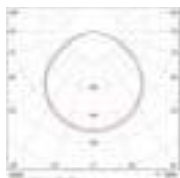

RoHS



IP66

IK08

CRI $\geq$ 70

4000K



50000 h



WARRANTY

PRODUCTION AND DELIVERY TIME - 3 MONTHS

## SPECIFICATIONS

- Explosion proof LED luminaire.
- Electronic fixed or dimmable output control gear.
- Housing: Pure aluminium A6063.
- Thermal Conductivity: 226W/m.K.
- Explosion proof driver.

## MODELS

| CODE       | MODEL                  | POWER | DIMENSION | LUMEN    |
|------------|------------------------|-------|-----------|----------|
| 6009000050 | EMET160_60W_LED_9600   | 60W   | 354x312mm | 9600 lm  |
| 6009000051 | EMET160_80W_LED_12800  | 80W   | 354x312mm | 12800 lm |
| 6009000052 | EMET160_100W_LED_16000 | 100W  | 354x312mm | 16000 lm |
| 6009000053 | EMET160_120W_LED_18000 | 120W  | 354x312mm | 18000 lm |
| 6009000054 | EMET160_150W_LED_22500 | 150W  | 354x312mm | 22500 lm |
| 6009000055 | EMET160_200W_LED_28000 | 200W  | 354x312mm | 28000 lm |



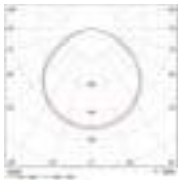

150LM/W



RoHS



IP66

IK10

CRI≥80



4000K



50000 h



WARRANTY

PRODUCTION AND DELIVERY TIME - 3 MONTHS

## SPECIFICATIONS

- Explosion proof LED luminaire.
- Electronic fixed or dimmable output control gear.
- Housing: Pure aluminium A6063.
- Explosion proof driver.

## MODELS

| CODE       | MODEL                 | POWER | DIMENSION    | LUMEN    |
|------------|-----------------------|-------|--------------|----------|
| 6009000045 | ENID150_20W_LED_3000  | 20W   | 600x70x58mm  | 3000 lm  |
| 6009000046 | ENID150_40W_LED_6000  | 40W   | 600x70x58mm  | 6000 lm  |
| 6009000047 | ENID150_40W_LED_6000  | 40W   | 1200x70x58mm | 6000 lm  |
| 6009000048 | ENID150_60W_LED_9000  | 60W   | 1200x70x58mm | 9000 lm  |
| 6009000049 | ENID150_80W_LED_12000 | 80W   | 1500x70x58mm | 12000 lm |

150LM/W

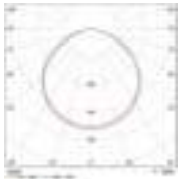

RoHS



IP66

IK08

CRI $\geq$ 70

4000K



50000 h



WARRANTY

PRODUCTION AND DELIVERY TIME - 3 MONTHS

## SPECIFICATIONS

- Explosion proof LED floodlight.
- Electronic fixed or dimmable output control gear.
- Housing: Pure aluminium A6063.
- Thermal Conductivity: 226W/m.K.
- Explosion proof driver.

## MODELS

| CODE       | MODEL                   | POWER | DIMENSION     | LUMEN    |
|------------|-------------------------|-------|---------------|----------|
| 6009000056 | ELGIN150_25W_LED_9600   | 25W   | 374x276x171mm | 9600 lm  |
| 6009000057 | ELGIN150_50W_LED_12800  | 50W   | 374x276x171mm | 12800 lm |
| 6009000058 | ELGIN150_70W_LED_16000  | 70W   | 374x276x171mm | 16000 lm |
| 6009000059 | ELGIN150_100W_LED_18000 | 100W  | 374x276x171mm | 18000 lm |
| 6009000060 | ELGIN150_150W_LED_22500 | 150W  | 374x276x171mm | 22500 lm |
| 6009000061 | ELGIN150_200W_LED_28000 | 200W  | 374x276x171mm | 28000 lm |



LED OUTDOOR  
LIGHT

**TOPE**   
**LIGHTING** 



RoHS    CE    IP65    IK08    CRI≥80    3000K    25000 h    WARRANTY

**SPECIFICATIONS**

- Modern design LED outdoor wall luminaires.
- IP65 protection class.
- Electronic fixed output control gear.
- Class I electrical.
- Housing: Die-cast Aluminum. Diffuser: Polycarbonate (PC).
- Operation Temperature: -40~50°C.
- Complete with 3000K CCT

**MODELS**

| CODE       | MODEL               | POWER | DIMENSION    | LUMEN   |
|------------|---------------------|-------|--------------|---------|
| 6008000053 | SAGA_G_12W_LED_1081 | 12W   | 135x60x210mm | 1081 lm |



- With microwave sensor. Microwave sensor maximum mounting height 3,5 m. Workplane 180°, 10 m from sensor.

**SAGA\_SENS**

SENSOR    RoHS    CE    IP65    IK08    CRI≥80    3000K    25000 h    WARRANTY

**MODELS**

| CODE       | MODEL                   | POWER | DIMENSION    | LUMEN   |
|------------|-------------------------|-------|--------------|---------|
| 6008100053 | SAGASENS_G_12W_LED_1080 | 12W   | 135x60x210mm | 1080 lm |



RoHS
CE
IP65
IK08
CRI≥80
3000K
25000 h
WARRANTY 3

**SPECIFICATIONS**

- Modern design LED outdoor wall luminaires.
- IP65 protection class.
- Electronic fixed output control gear.
- Class I electrical.
- Housing: Die-cast Aluminum. Diffuser: Polycarbonate (PC).
- Operation Temperature: -40~50°C.
- Complete with 3000K CCT

**MODELS**

| CODE       | MODEL              | POWER | DIMENSION    | LUMEN   |
|------------|--------------------|-------|--------------|---------|
| 6008000051 | SETO_G_5W_LED_1081 | 5W    | 100x68x157mm | 1081 lm |



- With microwave sensor. Microwave sensor maximum mounting height 3,5 m. Workplane 180°, 10 m from sensor.

**SETO\_SENS**

SENSOR
RoHS
CE
IP65
IK08
CRI≥80
3000K
25000 h
WARRANTY 3

**MODELS**

| CODE       | MODEL                  | POWER | DIMENSION    | LUMEN   |
|------------|------------------------|-------|--------------|---------|
| 6008100051 | SETOSENS_G_5W_LED_1080 | 5W    | 100x68x157mm | 1080 lm |



RoHS    CE    IP65    IK08    CRI≥80    3000K    25000 h    WARRANTY

**SPECIFICATIONS**

- Modern design LED outdoor wall luminaires.
- IP65 protection class.
- Electronic fixed output control gear.
- Class I electrical.
- Housing: Die-cast Aluminum. Diffuser: Polycarbonate (PC).
- Operation Temperature: -40~50°C.
- Complete with 3000K CCT

**MODELS**

| CODE       | MODEL                   | POWER | DIMENSION   | LUMEN   |
|------------|-------------------------|-------|-------------|---------|
| 6008000049 | SOMA_SQ_G_2x6W_LED_1080 | 2x6W  | 80x65x192mm | 1080 lm |



- With microwave sensor. Microwave sensor maximum mounting height 3,5 m. Workplane 180°, 10 m from sensor.

**SOMA\_SENS**

SENSOR    RoHS    CE    IP65    IK08    CRI≥80    3000K    25000 h    WARRANTY

**MODELS**

| CODE       | MODEL                       | POWER | DIMENSION   | LUMEN   |
|------------|-----------------------------|-------|-------------|---------|
| 6008100049 | SOMASENS_SQ_G_2x6W_LED_1080 | 2x6W  | 80x65x192mm | 1080 lm |



RoHS    CE    IP65    IK08    CRI≥80    3000K    25000 h    3 WARRANTY

**SPECIFICATIONS**

- Modern design LED outdoor wall luminaires.
- IP65 protection class.
- Electronic fixed output control gear.
- Class I electrical.
- Housing: Die-cast Aluminum. Diffuser: Polycarbonate (PC).
- Operation Temperature: -40~50°C.
- Complete with 3000K CCT

**MODELS**

| CODE       | MODEL                  | POWER | DIMENSION   | LUMEN   |
|------------|------------------------|-------|-------------|---------|
| 6008000047 | SANO_R_G_2x6W_LED_1081 | 2x6W  | 80x65x192mm | 1081 lm |



- With microwave sensor. Microwave sensor maximum mounting height 3,5 m. Workplane 180°, 10 m from sensor.

**SANO\_SENS**

SENSOR    RoHS    CE    IP65    IK08    CRI≥80    3000K    25000 h    3 WARRANTY

**MODELS**

| CODE       | MODEL                      | POWER | DIMENSION   | LUMEN   |
|------------|----------------------------|-------|-------------|---------|
| 6008100047 | SANOSENS_R_G_2x6W_LED_1081 | 2x6W  | 80x65x192mm | 1081 lm |



RoHS
CE
IP65
IK08
CRI≥80
3000K
25000 h
3 YEAR WARRANTY

**SPECIFICATIONS**

- Modern design LED outdoor wall luminaires.
- IP65 protection class.
- Electronic fixed output control gear.
- Class I electrical.
- Housing: Die-cast Aluminum. Diffuser: Polycarbonate (PC).
- Operation Temperature: -40~50°C.
- Complete with 3000K CCT

**MODELS**

| CODE       | MODEL                   | POWER | DIMENSION     | LUMEN   |
|------------|-------------------------|-------|---------------|---------|
| 6008000043 | SALTA_WA_G_12W_LED_1080 | 12W   | 140x140x230mm | 1080 lm |



- With microwave sensor. Microwave sensor maximum mounting height 3,5 m. Workplane 180°, 10 m from sensor.

**SALTA\_SENS**
SENSOR
RoHS
CE
IP65
IK08
CRI≥80
3000K
25000 h
3 YEAR WARRANTY

**MODELS**

| CODE       | MODEL                     | POWER | DIMENSION     | LUMEN |
|------------|---------------------------|-------|---------------|-------|
| 6008100043 | SALTASENS_WA_G_5W_LED_450 | 5W    | 140x140x230mm | 450lm |





RoHS
CE
IP65
IK08
CRI≥80
3000K
25000 h
3 WARRANTY

**SPECIFICATIONS**

- Modern design LED outdoor wall luminaires.
- IP65 protection class.
- Electronic fixed output control gear.
- Class I electrical.
- Housing: Die-cast Aluminum. Diffuser: Polycarbonate (PC).
- Operation Temperature: -40~50°C.
- Complete with 3000K CCT

**MODELS**

| CODE       | MODEL                    | POWER | DIMENSION     | LUMEN   |
|------------|--------------------------|-------|---------------|---------|
| 6008000044 | SALTA_BO_G__12W_LED_1080 | 12W   | 140x140x800mm | 1080 lm |

- With microwave sensor. Microwave sensor maximum mounting height 3,5 m. Workplane 180°, 10 m from sensor.

**SALTA\_SENS**

SENSOR
RoHS
CE
IP65
IK08
CRI≥80
3000K
25000 h
3 WARRANTY

**MODELS**

| CODE       | MODEL                      | POWER | DIMENSION     | LUMEN |
|------------|----------------------------|-------|---------------|-------|
| 6008100044 | SALTASENS_BO_G__5W_LED_450 | 5W    | 140x140x800mm | 450lm |



RoHS
CE
IP65
IK08
CRI≥80
3000K
25000 h
WARRANTY

**SPECIFICATIONS**

- Modern design LED outdoor wall luminaires.
- IP65 protection class.
- Electronic fixed output control gear.
- Class I electrical.
- Housing: Die-cast Aluminum. Diffuser: Polycarbonate (PC).
- Operation Temperature: -40~50°C.
- Complete with 3000K CCT

**MODELS**

| CODE       | MODEL                   | POWER | DIMENSION     | LUMEN   |
|------------|-------------------------|-------|---------------|---------|
| 6008000045 | SALTA_GR_G_12W_LED_1080 | 12W   | 140x140x800mm | 1080 lm |

- With microwave sensor. Microwave sensor maximum mounting height 3,5 m. Workplane 180°, 10 m from sensor.

**SALTA\_SENS**

SENSOR
RoHS
CE
IP65
IK08
CRI≥80
3000K
25000 h
WARRANTY

**MODELS**

| CODE       | MODEL                     | POWER | DIMENSION     | LUMEN |
|------------|---------------------------|-------|---------------|-------|
| 6008100045 | SALTASENS_GR_G_5W_LED_450 | 5W    | 140x140x800mm | 450lm |



LED  
FLOODLIGHT

**TOPE** &  
**LIGHTING**



150LM/W



RoHS



IP66

IK08

CRI≥80



4000K



50000 h



WARRANTY

### SPECIFICATIONS

- FLOOD LIGHT LED luminaire.
- Electronic fixed output control gear.
- Class I electrical.
- Housing: Die-cast Aluminum ADC 12
- Lens/Diffuser: PMMA LENS.
- Dimming: Fixed output.

### MODELS

| CODE       | MODEL                   | POWER | DIMENSION    | LUMEN    |
|------------|-------------------------|-------|--------------|----------|
| 6009000027 | TENRI150_50W_LED_7500   | 50W   | 280x245x53mm | 7500 lm  |
| 6009000028 | TENRI150_100W_LED_15000 | 100W  | 354x319x53mm | 15000 lm |
| 6009000029 | TENRI150_150W_LED_22500 | 150W  | 400x359x63mm | 22500 lm |
| 6009000030 | TENRI150_200W_LED_30000 | 200W  | 430x389x63mm | 30000 lm |

### ACCESSORIES:

|            |  |   |
|------------|--|---|
| 6009900027 | TENRI plug-in Micro wave sensor + day light sensor | * |
| 6009900028 | TENRI plug-in PIR sensor + day light sensor        | * |

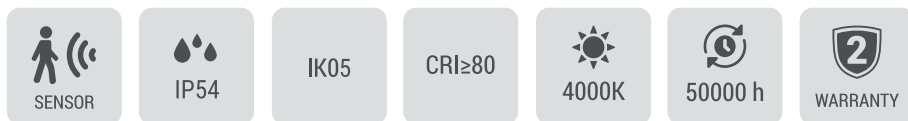

### SPECIFICATIONS

- LED floodlight with solar battery. IP54, IK05.
- Body: polycarbonate white (RAL 9016), polycarbonate black (RAL 9005). Diffuser: acrylic opal.
- Complete with 4000K LED
- With microwave sensor.

### MODELS

| CODE       | MODEL                   | POWER | DIMENSION      | LUMEN   |
|------------|-------------------------|-------|----------------|---------|
| 6008000030 | VISTA120_10W_B_LED_1200 | 10W   | 290x178x140 mm | 1200 lm |
| 6008000031 | VISTA120_10W_W_LED_1200 | 10W   | 290x178x140 mm | 1200 lm |



|             |           |             |             |               |              |                |                 |
|-------------|-----------|-------------|-------------|---------------|--------------|----------------|-----------------|
| <b>RoHS</b> | <b>CE</b> | <b>IP65</b> | <b>IK08</b> | <b>CRI≥80</b> | <b>6500K</b> | <b>30000 h</b> | <b>WARRANTY</b> |
|-------------|-----------|-------------|-------------|---------------|--------------|----------------|-----------------|

**SPECIFICATIONS**

- Brent LED floodlight has new innovative design.
- Protection class IP65. Impact resistance IK08.
- Housing aluminum (AS9U), coated with grey (RAL 9007) powder coating.
- The front of the floodlight is clear polycarbonate (PC).
- Very easy to attach. 90° tilt on one side is possible. When the bracket is attached to the other side, the tilt is 90° to the other side.
- The set includes the necessary mounting bolts and wrench.
- Complete with 6500K LED.

**MODELS**

| CODE       | MODEL                 | POWER | DIMENSION     | LUMEN   |
|------------|-----------------------|-------|---------------|---------|
| 6008000020 | BRENT120_30W_LED_3600 | 30W   | 140x135x65 mm | 3103 lm |



- With microwave sensor. Microwave sensor maximum mounting height 3,5 m. Workplane 180°, 10 m from sensor.

**BRENT\_SENS**

|               |             |           |             |             |               |              |                |                 |
|---------------|-------------|-----------|-------------|-------------|---------------|--------------|----------------|-----------------|
| <b>SENSOR</b> | <b>RoHS</b> | <b>CE</b> | <b>IP65</b> | <b>IK08</b> | <b>CRI≥80</b> | <b>6500K</b> | <b>30000 h</b> | <b>WARRANTY</b> |
|---------------|-------------|-----------|-------------|-------------|---------------|--------------|----------------|-----------------|

**MODELS**

| CODE       | MODEL                  | POWER | DIMENSION     | LUMEN   |
|------------|------------------------|-------|---------------|---------|
| 6008100007 | BRENTSENS_50W_LED_6000 | 50 W  | 170x135x65 mm | 5118 lm |





RoHS

  
 IP65

IK03

CRI≥80

  
 4000K

  
 50000 h

  
 WARRANTY





### SPECIFICATIONS

- LED floodlight with symmetric distribution for creating light. IP65, IK03.
- Body: die-cast Aluminum (AS9U), powder coated black (RAL 9005).
- Enclosure: clear glass. Supplied in one box, ready to install.
- Complete with 4000K LED

### MODELS

| CODE       | MODEL                 | POWER | DIMENSION     | LUMEN   |
|------------|-----------------------|-------|---------------|---------|
| 6008100022 | TAMASENS_10W_LED_1200 | 10W   | 145x112x44 mm | 1200 lm |
| 6008100023 | TAMASENS_20W_LED_2400 | 20W   | 150x140x44 mm | 2400 lm |
| 6008100024 | TAMASENS_30W_LED_3600 | 30W   | 175x175x44 mm | 3600 lm |
| 6008100025 | TAMASENS_50W_LED_5500 | 50W   | 210x185x44 mm | 5500 lm |



|             |  |             |               |   |   |   |
|-------------|--|-------------|---------------|---|---|---|
| <b>RoHS</b> | <br><b>IP65</b> | <b>IK05</b> | <b>CRI≥80</b> | <br><b>4000K</b> | <br><b>50000 h</b> | <br><b>3 WARRANTY</b> |
|-------------|--|-------------|---------------|---|---|---|

**SPECIFICATIONS**

- LED floodlight with symmetric distribution for creating light. IP65, IK05.
- Body: die-cast Aluminum (AS9U), powder coated black (RAL 9005).
- Enclosure: clear glass. Supplied in one box, ready to install.
- Complete with 4000K LED

**MODELS**

| CODE       | MODEL                  | POWER | DIMENSION     | LUMEN   |
|------------|------------------------|-------|---------------|---------|
| 6008000001 | TOLEDO90_10W_LED_900   | 10W   | 101x72x28 mm  | 850 lm  |
| 6008000002 | TOLEDO90_20W_LED_1800  | 20W   | 114x94x28 mm  | 1690 lm |
| 6008000003 | TOLEDO90_30W_LED_2700  | 30W   | 155x126x28 mm | 2480 lm |
| 6008000004 | TOLEDO90_50W_LED_4500  | 50W   | 187x147x28 mm | 4040 lm |
| 6008000010 | TOLEDO90_70W_LED_6300  | 70W   | 223x189x28 mm | 6078 lm |
| 6008000011 | TOLEDO90_100W_LED_9000 | 100W  | 260x225x30 mm | 8954 lm |



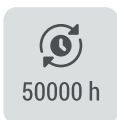
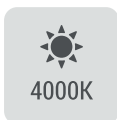
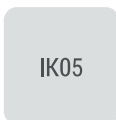
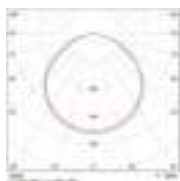

**SPECIFICATIONS**

- LED floodlight with symmetric distribution for creating light. IP54, IK05.
- Body: die-cast Aluminum (AS9U), powder coated black (RAL 9005).
- Enclosure: clear glass. Supplied in one box, ready to install.
- Complete with 4000K LED
- With microwave sensor.

**MODELS**

| CODE       | MODEL                      | POWER | DIMENSION    | LUMEN  |
|------------|----------------------------|-------|--------------|--------|
| 6008100008 | TOLEDOSENS90_10W_LED_900   | 10W   | 170x120x48mm | 900lm  |
| 6008100009 | TOLEDOSENS90_20W_LED_1800  | 20W   | 170x120x48mm | 1800lm |
| 6008100010 | TOLEDOSENS90_30W_LED_2700  | 30W   | 200x150x48mm | 2700lm |
| 6008100011 | TOLEDOSENS90_50W_LED_4500  | 50W   | 230x180x48mm | 4500lm |
| 6008100012 | TOLEDOSENS90_70W_LED_6300  | 70W   | 268x220x48mm | 6300lm |
| 6008100013 | TOLEDOSENS90_100W_LED_9000 | 100W  | 295x250x48mm | 9000lm |



LED STREET  
LIGHT

TOPE<sup>®</sup>  
LIGHTING

160LM/W



IK08

CRI $\geq$ 70

4000K



50000 h



WARRANTY

### SPECIFICATIONS

- LED road lighting lantern.
- Electronic fixed output control gear.
- Class II electrical.
- Housing: Die-cast Aluminum.
- Diffuser: tempered glass PMMA lens.

### PROJECT CATEGORY

### MODELS

| CODE       | MODEL                   | POWER | DIMENSION     | LUMEN    |
|------------|-------------------------|-------|---------------|----------|
| 6008000032 | HEMET160_24W_LED_3840   | 24W   | 515x190x99mm  | 3840 lm  |
| 6008000033 | HEMET160_40W_LED_6400   | 40W   | 515x190x99mm  | 6400 lm  |
| 6008000034 | HEMET160_60W_LED_9600   | 60W   | 515x190x99mm  | 9600 lm  |
| 6008000035 | HEMET160_80W_LED_12800  | 80W   | 575x242x109mm | 12800 lm |
| 6008000036 | HEMET160_100W_LED_15000 | 100W  | 575x242x109mm | 15000 lm |
| 6008000037 | HEMET160_120W_LED_18000 | 120W  | 615x262x109mm | 18000 lm |
| 6008000038 | HEMET160_150W_LED_22500 | 150W  | 615x262x109mm | 22500 lm |
| 6008000039 | HEMET160_180W_LED_27000 | 180W  | 685x287x109mm | 27000 lm |
| 6008000040 | HEMET160_200W_LED_30000 | 200W  | 685x287x109mm | 30000 lm |

### ACCESORIES:

|            |  |
|------------|--|
| 6008900032 | HEMET Surge protector 10kV   |
| 6008900033 | HEMET Surge protector 20kV   |
| 6008900034 | HEMET Street light photocell. Function: "on/of"  |
| 6008900035 | HEMET Street light photocell. Function: constant illuminance, auto dimming, midnight automatically dim down                            |
| 6008900036 | HEMET Street light photocell. Function: constant illuminance, auto dimming, midnight automatically dim down. App: smart phone controll |

### PRODUCTION AND DELIVERY TIME - 3 MONTHS

 160LM/W

IP66

IK08

CRI≥80



4000K



50000 h



WARRANTY

PRODUCTION AND DELIVERY TIME - 3 MONTHS

## SPECIFICATIONS

- LED road lighting lantern.
- Electronic fixed output control gear.
- Class II electrical.
- Housing: Die-cast Aluminum.
- Diffuser: tempered glass PMMA lens.





## MODELS

| CODE       | MODEL                  | POWER | DIMENSION     | LUMEN    |
|------------|------------------------|-------|---------------|----------|
| 6008000041 | HEZE160_24W_LED_3840   | 24W   | 568x200x109mm | 3840 lm  |
| 6008000042 | HEZE160_40W_LED_6400   | 40W   | 568x200x109mm | 6400 lm  |
| 6008000043 | HEZE150_60W_LED_9000   | 60W   | 568x200x109mm | 9000 lm  |
| 6008000044 | HEZE150_80W_LED_12000  | 80W   | 613x240x109mm | 12000 lm |
| 6008000045 | HEZE150_100W_LED_15000 | 100W  | 613x240x109mm | 15000 lm |
| 6008000046 | HEZE140_120W_LED_16800 | 120W  | 613x240x109mm | 16800 lm |
| 6008000047 | HEZE140_150W_LED_21000 | 150W  | 683x260x109mm | 21000 lm |
| 6008000048 | HEZE140_180W_LED_25200 | 180W  | 693x300x109mm | 25200 lm |
| 6008000049 | HEZE140_200W_LED_28000 | 200W  | 693x300x109mm | 28000 lm |

## ACCESSORIES:

|            |   |
|------------|---|
| 6008900041 | HEZE Surge protector 10kV   |
| 6008900042 | HEZE Surge protector 20kV   |
| 6008900043 | HEZE Street light photocell. Function: "on/of"  |
| 6008900044 | HEZE Street light photocell. Function: constant illuminance, auto dimming, midnight automatically dim down                            |
| 6008900045 | HEZE Street light photocell. Function: constant illuminance, auto dimming, midnight automatically dim down. App: smart phone controll |



|  |             |               |   |   |  |  |
|--|-------------|---------------|---|---|--|--|
| <br><b>IP66</b> | <b>IK08</b> | <b>CRI≥70</b> | <br><b>4000K</b> | <br><b>50000 h</b> | <br><b>WARRANTY</b> | <br><b>120°</b> |
|--|-------------|---------------|---|---|--|--|

### SPECIFICATIONS

- LED road lighting lantern.
- Electronic, fixed output control gear. IP66, IK08.
- Housing: die-cast Aluminum, powder coated textured light grey.
- Diffuser: tempered flat glass. Screws: stainless steel.
- Housing has adapter for adjustment. (-15°/-10°/-5°/0°/+5°/+10°/+15°)
- Complete with 4000K LED.

### MODELS

| CODE       | MODEL                  | POWER | DIMENSION    | LUMEN   |
|------------|------------------------|-------|--------------|---------|
| 6008000026 | HABI100_30W_LED_3000   | 30W   | 397x150x60mm | 3000lm  |
| 6008000027 | HABI100_50W_LED_5000   | 50W   | 395x150x65mm | 5000lm  |
| 6008000028 | HABI100_80W_LED_8000   | 80W   | 470x168x63mm | 8000lm  |
| 6008000029 | HABI100_100W_LED_10000 | 100W  | 470x168x63mm | 10000lm |



PARK LIGHT

**TOPE** and  
**LIGHTING**



IK08

CRI $\geq$ 803000K  
4000K

50000 h



WARRANTY

## PRODUCTION AND DELIVERY TIME - 3 MONTHS

## SPECIFICATIONS

- GARDEN LIGHT LED luminaire.
- Electronic fixed output control gear.
- Class I electrical.
- Housing: Die-cast Aluminum.
- Lens/Diffuser: PMMA LENS.  
Symetric or asymeric light distribution.
- Dimming: Fixed output.

## MODELS

| CODE       | MODEL                 | POWER | DIMENSION | LUMEN    |
|------------|-----------------------|-------|-----------|----------|
| 6009000062 | GIZA170_30W_LED_5100  | 30W   | 422x539mm | 5100 lm  |
| 6009000042 | GIZA170_40W_LED_6800  | 40W   | 422x539mm | 6800 lm  |
| 6009000043 | GIZA170_60W_LED_9600  | 60W   | 422x539mm | 9600 lm  |
| 6009000044 | GIZA170_90W_LED_13500 | 90W   | 422x539mm | 13500 lm |

## ACCESSORIES:

|            |   |
|------------|---|
| 6009900041 | GIZA SPD Surge protector 20kV                       |
| 6009900042 | GIZA Installation adapter compatible with 60mm pole |



LED HIGH MAST  
LIGHT

**TOPE** &  
**LIGHTING**





IP66

IK08

CRI $\geq$ 80

4000K



50000 h



WARRANTY

PRODUCTION AND DELIVERY TIME - 3 MONTHS

## SPECIFICATIONS

- High mast LED luminaire for sport fields.
- Electronic, fixed output control gear, external driver.
- Class I electrical.
- Housing: Pure aluminium
- Lens/Diffuser: PMMA LENS with antiglaring film.
- Thermal Conductivity: 96W/m.K.
- Dimming: Fixed output, or with Knob dimmer.

## MODELS

| CODE       | MODEL                    | POWER | DIMENSION     | LUMEN     |
|------------|--------------------------|-------|---------------|-----------|
| 6009000019 | DINA190_500W_LED_95000   | 500W  | 592x509x263mm | 95000 lm  |
| 6009000020 | DINA190_600W_LED_108000  | 600W  | 592x509x263mm | 108000 lm |
| 6009000021 | DINA190_800W_LED_152000  | 800W  | 697x649x263mm | 152000 lm |
| 6009000022 | DINA180_1000W_LED_180000 | 1000W | 697x649x263mm | 180000 lm |

## ACCESORIES:

|            |   |
|------------|---|
| 6009900019 | DINA SPD Surge protector 20kV   |
| 6009900020 | DINA Laser sight aiming device with distance maximum 1000m                      |
| 6009900021 | DINA DMX RDM to 0-10V Converter IP67  |
| 6009900022 | DINA 0-10V Knob Dimmer. Dimming range 0-100%. Power adjustable from 0W to 1200W |



IP66

IK08

CRI $\geq$ 80

4000K



50000 h



WARRANTY

PRODUCTION AND DELIVERY TIME - 3 MONTHS

## SPECIFICATIONS

- High mast LED luminaire for sport fields.
- Electronic, fixed output control gear, external driver.
- Class I electrical.
- Housing: Pure aluminium
- Lens/Diffuser: PMMA LENS with antiglare film.
- Thermal Conductivity: 96W/m.K.
- Dimming: Fixed output, or with Knob dimmer.

## MODELS

| CODE      | MODEL                | POWER | DIMENSION     | LUMEN     |
|-----------|----------------------|-------|---------------|-----------|
| 600900023 | DEVA160 HM500PE2F-CM | 500W  | 721x315x158mm | 80000 lm  |
| 600900024 | DEVA160 HM600PE3F-CM | 600W  | 721x315x158mm | 96000 lm  |
| 600900025 | DEVA160 HM1K0PE4F-CM | 1000W | 810x502x158mm | 160000 lm |
| 600900026 | DEVA160 HM1K2PE5F-CM | 1200W | 810x502x158mm | 192000 lm |
| 600900063 | DEVA160 HM1K5PE6F-CM | 1500W | 810x704x158mm | 240000 lm |
| 600900064 | DEVA160HM1K8PE7F-CM  | 1800W | 810x704x158mm | 288000 lm |

## ACCESSORIES:

|           |  |
|-----------|--|
| 600990023 | DEVA visor for reducing upward light pollution             |
| 600990024 | DEVA Laser sight aiming device with distance maximum 1000m |
| 600990025 | DEVA driver box  |
| 600990026 | DEVA DMX RDM to 0-10V Converter IP67                       |

150LM/W

UGR&lt;21



RoHS



IP66

IK08

CRI≥80



4000K



50000 h



WARRANTY

PRODUCTION AND DELIVERY TIME - 3 MONTHS

## SPECIFICATIONS

- FLOOD LIGHT LED luminaire.
- Electronic fixed output control gear.
- Class I electrical.
- Housing: Die-cast Aluminum ADC 12
- Lens/Diffuser: PMMA LENS with anti glare film.
- UGR<21.
- Dimming: Fixed output.

## MODELS

| CODE      | MODEL                 | POWER | DIMENSION    | LUMEN    |
|-----------|-----------------------|-------|--------------|----------|
| 600900031 | TOGAN140 HM100NE1G-CM | 100W  | 461x320x69mm | 14000 lm |
| 600900032 | TOGAN140 HM150NE1G-CM | 150W  | 461x320x69mm | 21000 lm |
| 600900033 | TOGAN140 HM200NE1G-CM | 200W  | 461x380x69mm | 28000 lm |
| 600900034 | TOGAN140 HM240NE1G-CM | 240W  | 534x440x69mm | 33600 lm |
| 600900035 | TOGAN140 HM300NE1G-CM | 300W  | 534x440x69mm | 42000 lm |

## ACCESSORIES:

|            |   |
|------------|---|
| 6009900031 | TOGAN SPD SURGE PROTECTOR 20kV                      |
| 6009900032 | TOGAN Stainless steel mech protection for 100, 150W |
| 6009900033 | TOGAN Stainless steel mech protection for 200W      |
| 6009900034 | TOGAN Stainless steel mech protection for 240, 300W |



150LM/W

RoHS



IP65

IK08

CRI $\geq$ 70

4000K



50000 h



WARRANTY

PRODUCTION AND DELIVERY TIME - 3 MONTHS

## SPECIFICATIONS

- Dust and moisture resistant LED Tennis/Padel court linear luminaire.
- Electronic, fixed output control gear.
- Body: Pour Aluminium.
- For surface mounting, ceiling or fence corner mounting Anti-glaring technology.
- Suitable for use in un-protected outdoor areas.
- Complete with two side connectors for connecting to the line.

## MODELS

| CODE       | MODEL                 | POWER | DIMENSION     | LUMEN | KELVIN |
|------------|-----------------------|-------|---------------|-------|--------|
| 6007000039 | NOTA150_30W_LED_4500  | 30W   | 1511x117x83mm | 4500  | 4000K  |
| 6007000040 | NOTA150_43W_LED_6450  | 43W   | 1511x117x83mm | 6450  | 4000K  |
| 6007000041 | NOTA150_60W_LED_9000  | 60W   | 1511x117x83mm | 9000  | 4000K  |
| 6007000042 | NOTA150_80W_LED_12000 | 80W   | 1511x117x83mm | 12000 | 4000K  |

150LM/W

UGR&lt;21



RoHS



IP66

IK08

CRI≥80



4000K



50000 h



WARRANTY

PRODUCTION AND DELIVERY TIME - 3 MONTHS

## SPECIFICATIONS

- FLOOD LIGHT LED luminaire.
- Electronic fixed output control gear.
- Class I electrical.
- Housing: Die-cast Aluminum ADC 12
- Lens/Diffuser: PMMA LENS with anti glare film.
- UGR<21.
- Dimming: Fixed output.

## MODELS

| CODE       | MODEL                     | POWER | DIMENSION    | LUMEN    |
|------------|---------------------------|-------|--------------|----------|
| 6009000036 | TRENTON150_100W_LED_15000 | 100W  | 292x246x53mm | 15000 lm |
| 6009000037 | TRENTON150_150W_LED_22500 | 150W  | 336x146x53mm | 22500 lm |
| 6009000038 | TRENTON150_200W_LED_30000 | 200W  | 407x328x53mm | 30000 lm |
| 6009000039 | TRENTON150_240W_LED_36000 | 240W  | 407x328x53mm | 36000 lm |
| 6009000040 | TRENTON150_300W_LED_45000 | 300W  | 496x411x71mm | 45000 lm |
| 6009000041 | TRENTON150_400W_LED_60000 | 400W  | 496x411x71mm | 60000 lm |

## ACCESORIES:

|            |   |
|------------|---|
| 6009900036 | TRENTON SPD SURGE PROTECTOR 20kV                      |
| 6009900037 | TRENTON metal visor                                   |
| 6009900038 | TRENTON Stainless steel mech protection for 100, 150W |
| 6009900039 | TRENTON Stainless steel mech protection for 200, 240W |
| 6009900040 | TRENTON Stainless steel mech protection for 300, 400W |

# VESTA NARROW



IP40



IK03



CRI $\geq$ 70



4000K

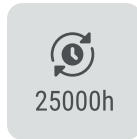

25000h



WARRANTY

## MODELS

| CODE       | MODEL                        | POWER | DIMENSION | LUMEN   |
|------------|------------------------------|-------|-----------|---------|
| VESTA1022R | VESTA NARROW LED PANEL ROUND | 6W    | Ø 100     | 402 lm  |
| VESTA1023R | VESTA NARROW LED PANEL ROUND | 8W    | Ø 118     | 518 lm  |
| VESTA1024R | VESTA NARROW LED PANEL ROUND | 15W   | Ø 175     | 1077 lm |

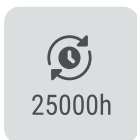
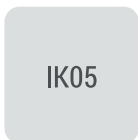
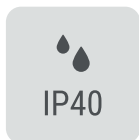

## MODELS

| CODE       | MODEL                 | POWER | DIMENSION | LUMEN |
|------------|-----------------------|-------|-----------|-------|
| VESTA 001R | VESTA LED PANEL ROUND | 3W    | Ø85mm     | 203   |
| VESTA 002R | VESTA LED PANEL ROUND | 6W    | Ø120mm    | 407   |
| VESTA 003R | VESTA LED PANEL ROUND | 12W   | Ø170mm    | 839   |
| VESTA 004R | VESTA LED PANEL ROUND | 18W   | Ø220mm    | 1347  |

| CODE       | MODEL                  | POWER | DIMENSION | LUMEN |
|------------|------------------------|-------|-----------|-------|
| VESTA 005S | VESTA LED PANEL SQUARE | 3W    | 85x85mm   | 203   |
| VESTA 006S | VESTA LED PANEL SQUARE | 6W    | 120x120mm | 407   |
| VESTA 007S | VESTA LED PANEL SQUARE | 12W   | 170x170mm | 839   |
| VESTA 008S | VESTA LED PANEL SQUARE | 18W   | 220x220mm | 1347  |

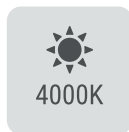
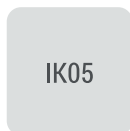
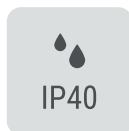

| CODE       | MODEL                  | POWER | DIMENSION    | LUMEN |
|------------|------------------------|-------|--------------|-------|
| VESTA 015S | VESTA LED PANEL SQUARE | 40W   | 595x595x30mm | 3996  |

# VESTA GLASS

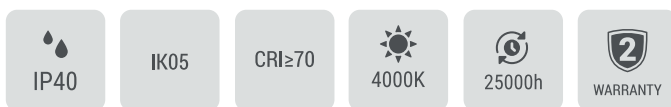

## MODELS

| CODE       | MODEL                       | POWER | DIMENSION | LUMEN |
|------------|-----------------------------|-------|-----------|-------|
| VESTA 009R | VESTA LED GLASS PANEL ROUND | 6W    | ∅97mm     | 407   |
| VESTA 010R | VESTA LED GLASS PANEL ROUND | 12W   | ∅160mm    | 839   |
| VESTA 011R | VESTA LED GLASS PANEL ROUND | 18W   | ∅200mm    | 1347  |

| CODE       | MODEL                        | POWER | DIMENSION | LUMEN |
|------------|------------------------------|-------|-----------|-------|
| VESTA 012S | VESTA LED GLASS PANEL SQUARE | 6W    | 97x97mm   | 407   |
| VESTA 013S | VESTA LED GLASS PANEL SQUARE | 12W   | 160x160mm | 839   |
| VESTA 014S | VESTA LED GLASS PANEL SQUARE | 18W   | 200x200mm | 1347  |

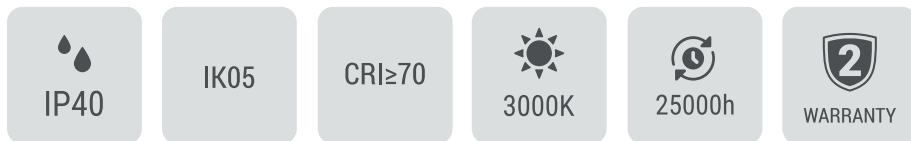

## MODELS

| CODE       | MODEL                       | POWER | DIMENSION | LUMEN |
|------------|-----------------------------|-------|-----------|-------|
| VESTA 016R | VESTA LED GLASS PANEL ROUND | 6W    | ∅97mm     | 407   |
| VESTA 017R | VESTA LED GLASS PANEL ROUND | 12W   | ∅160mm    | 839   |
| VESTA 018R | VESTA LED GLASS PANEL ROUND | 18W   | ∅200mm    | 1347  |

| CODE       | MODEL                        | POWER | DIMENSION | LUMEN |
|------------|------------------------------|-------|-----------|-------|
| VESTA 019S | VESTA LED GLASS PANEL SQUARE | 6W    | 97x97mm   | 407   |
| VESTA 020S | VESTA LED GLASS PANEL SQUARE | 12W   | 160x160mm | 839   |
| VESTA 021S | VESTA LED GLASS PANEL SQUARE | 18W   | 200x200mm | 1347  |



# MODELED-NARROW



IP40
IK05
CRI $\geq$ 70
25000h
25000h
WARRANTY

## MODELS

| CODE     | MODEL                       | POWER | DIMENSION | LUMEN |
|----------|-----------------------------|-------|-----------|-------|
| MLP1021R | NARROW EDGE LED PANEL ROUND | 6W    | Ø100mm    | 402   |
| MLP1022R | NARROW EDGE LED PANEL ROUND | 8W    | Ø118mm    | 518   |
| MLP1023R | NARROW EDGE LED PANEL ROUND | 15W   | Ø175mm    | 1077  |



IP40
IK05
CRI $\geq$ 70
25000h
25000h
WARRANTY

## MODELS

| CODE     | MODEL                        | POWER | DIMENSION | LUMEN |
|----------|------------------------------|-------|-----------|-------|
| MLP1025S | NARROW EDGE LED PANEL SQUARE | 6W    | 100x100mm | 407   |
| MLP1026S | NARROW EDGE LED PANEL SQUARE | 8W    | 118x118mm | 511   |
| MLP1027S | NARROW EDGE LED PANEL SQUARE | 15W   | 175x175mm | 1062  |



IP40
IK05
CRI≥70
3000K
25000h
WARRANTY 2

## MODELS

| CODE     | MODEL                   | POWER | DIMENSION  | LUMEN |
|----------|-------------------------|-------|------------|-------|
| MLP1001R | MODOLED LED PANEL ROUND | 3W    | Ø85x1,5mm  | 208   |
| MLP1002R | MODOLED LED PANEL ROUND | 6W    | Ø120x1,5mm | 409   |
| MLP1003R | MODOLED LED PANEL ROUND | 12W   | Ø170x1,5mm | 852   |
| MLP1004R | MODOLED LED PANEL ROUND | 18W   | Ø220x1,5mm | 1265  |



IP40
IK05
CRI≥70
3000K
25000h
WARRANTY 2

## MODELS

| CODE     | MODEL                    | POWER | DIMENSION     | LUMEN |
|----------|--------------------------|-------|---------------|-------|
| MLP1007S | MODOLED LED PANEL SQUARE | 6W    | 120x120x1,5mm | 409   |
| MLP1008S | MODOLED LED PANEL SQUARE | 12W   | 170x170x1,5mm | 852   |
| MLP1009S | MODOLED LED PANEL SQUARE | 18W   | 220x220x1,5mm | 1265  |
| MLP1010S | MODOLED LED PANEL SQUARE | 24W   | 295x295x1,5mm | 1685  |

# MODOLED GLASS

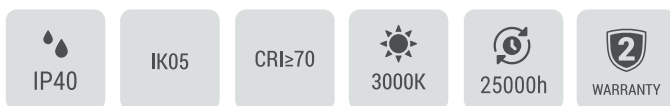

## MODELS

| CODE     | MODEL                         | POWER | DIMENSION | LUMEN |
|----------|-------------------------------|-------|-----------|-------|
| MLP1011R | MODOLED LED GLASS PANEL ROUND | 6W    | Ø97mm     | 411   |
| MLP1012R | MODOLED LED GLASS PANEL ROUND | 12W   | Ø160mm    | 855   |
| MLP1013R | MODOLED LED GLASS PANEL ROUND | 18W   | Ø200mm    | 1263  |



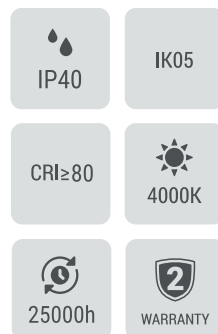

| CODE     | MODEL                          | POWER | DIMENSION | LUMEN |
|----------|--------------------------------|-------|-----------|-------|
| MLP1014S | MODOLED LED GLASS PANEL SQUARE | 6W    | 95x95mm   | 411   |
| MLP1015S | MODOLED LED GLASS PANEL SQUARE | 12W   | 160x160mm | 855   |
| MLP1016S | MODOLED LED GLASS PANEL SQUARE | 18W   | 200x200mm | 1263  |



| CODE     | MODEL                    | POWER | DIMENSION    | LUMEN |
|----------|--------------------------|-------|--------------|-------|
| MLP1029S | MODOLED LED PANEL SQUARE | 40W   | 595x595x30mm | 3996  |







# MODOLED FLOODLIGHT WITH PIR SENSOR



-  IP65
- IK05
- CRI $\geq$ 70
-  4000K
-  25000h
-  2 WARRANTY

## MODELS

| CODE     | MODEL                  | POWER | DIMENSION    | LUMEN |
|----------|------------------------|-------|--------------|-------|
| MLP1039F | MODOLED LED FLOODLIGHT | 20W   | 115x90x26mm  | 1800  |
| MLP1040F | MODOLED LED FLOODLIGHT | 30W   | 150x115x28mm | 2700  |

|   | CODE      | MODEL   |
|---|-----------|---|
|    | 500600001 | 10AX 250V One gang switch (surface) Alba          |
|    | 500600002 | 10AX 250V Two gang switch (surface) Alba          |
|    | 500600003 | 16A 250V One gang socket (with ground.) Alba      |
|    | 500600004 | 16A One gang socket(surface)+ 10A250V Switch Alba |
|   | 500600005 | 16A 250V Two gang socket (with ground.) Alba      |
|  | 500600006 | 16A 250V Three gang socket (with ground.) Alba    |
|  | 500600007 | 16A 250V Four gang socket (with ground.) Alba     |

|   | CODE      | MODEL  |
|---|-----------|--|
|    | 500700001 | 10A 250V One gang one way switch (surface) Bela            |
|    | 500700002 | 10A 250V One gang one way switch with indic.(surface) Bela |
|    | 500700003 | 10A 250V Two gang one way swiche (surface) Bela            |
|    | 500700004 | One gang doorbell with indic. (surface) Bela               |
|   | 500700005 | 16A 250V One gang socket (with ground.) Bela               |
|  | 500700006 | 16A 250V Double gang socket (with ground.) Bela            |
|  | 500700007 | 16A One gang+ 10A 250V socket Bela                         |





**TOPE LIGHTING LITHUANIA**

E-Mail Address [info@topenerga.lt](mailto:info@topenerga.lt)

Mob.: +370 612 12889

**TOPE LIGHTING LATVIA / ESTONIA**

E-Mail Address [sales.lv@topenerga.lt](mailto:sales.lv@topenerga.lt)

Mob.: +371 247 95344

**TOPE LIGHTING WORLD WIDE**

E-Mail Address [sales.lv@topenerga.lt](mailto:sales.lv@topenerga.lt)

Mob.: +371 247 95344